



Icom America, Inc.
Corporate Headquarters
2380 116th Ave. N.E.
Bellevue, Washington 98004
Phone: (425) 454-8155
Fax: (425) 454-1509
Customer Service: (425) 454-7619

CI-V

ICOM COMMUNICATIONS INTERFACE-V

REFERENCE MANUAL

---ver 3.2---

-2002-

First in Communications

*Gold
2/26*

ADDENDUM

CI-V command formats for the Icom radios listed below have been added to the back of this booklet. They are also available in the radio user guide.

1-706

2-706MKII

3-706MKIIG

4-707

5-718

6-746

7-746PRO

8-756

9-756PRO

10-756PROII

11-820H

12-821H

13-910H

14-R10

15-R8500

16-703

17-7800

FOREWORD

We have introduced the CI-V (Icom Communication Interface-V) System, an advanced remote control LAN (Local Area Network).

With this system, you can control Icom's recent HF transceivers, all mode transceivers and nearly all receivers remotely.

A variety of functions including the operating frequency, mode and memory channel can be changed via your personal computer.

EXPLICIT DEFINITIONS

The following explicit definitions apply to this reference manual.

Word	Definition
 WARNING	Personal injury, fire hazard or electric shock may occur.
CAUTION	Equipment damage may occur.
NOTE	If ignored, inconvenience only. No personal injury or risk of electric shock.

PRECAUTIONS

 **NEVER** connect the CT-17 CI-V LEVEL CONVERTER to an AC outlet. This will ruin any connected equipment and electric shock may occur.

DISCONNECT all AC and DC power cables from the radios before performing any connections or internal work.

DO NOT apply more than 15 V DC to the CT-17. Check power source voltage before connecting the DC power cable.

If a non-Icom CI-V level converter is used, accurate operation is not guaranteed. The use of Icom's CT-17 is recommended.

Icom has strived to make all information as precise as possible. However, **NO** liability is accepted with respect to the use of the information herein. To include the newest information, all stated contents are subject to change without notice or obligation.

INTRODUCTION

This reference manual explains the basic theory of the CI-V System, general operating method, and all current functions.

Available functions differ according to radios. (Section 4)

Before operation, condition setting **MUST** be performed for both your personal computer and each radio. (Sections 2-1-2-11)

Parameter setting methods differ according to computers and programming languages. Refer to the instruction manual of your computer and programming language. (Section 2-7)

APPLICABLE RADIOS

	Model
HF transceivers	IC-725, IC-726, IC-728, IC-729, IC-735, IC-737, IC-751, IC-751A, IC-761, IC-765, IC-781
All mode transceivers	IC-271A/E/H, IC-471A/E/H, IC-1271A/E, IC-575A/H, IC-275A/E/H, IC-375A, IC-475A/E/H, IC-1275A/E, IC-970A/E/H
Receivers	IC-R71A/E/D, IC-R72, IC-R7000, IC-R7100, IC-R9000

SOFTWARE

Commercially-made software from other companies may be available for the CI-V System. Freeware or shareware may be available from BBS's or RBBS's. Ask your Icom Dealer for details.

Icom does not yet supply any software for the CI-V System. However, the later pages of the CT-17 instruction manual include sample programs. All programs **MUST** be modified to suit your computer.

COPYRIGHT

All rights for the CI-V System and this reference manual are reserved by Icom Inc. Production or publication of the content in any manner, without express permission of Icom Inc. is prohibited.

TABLE OF CONTENTS

FOREWORD.....	i	5. MESSAGE FORMAT	pgs. 5-1~5-4
EXPLICIT DEFINITIONS.....	i	5-1 Basic message format.....	p. 5-1
PRECAUTIONS.....	i	5-2 Frequency data format.....	p. 5-3
INTRODUCTION	j	5-3 Memory blank code.....	p. 5-3
APPLICABLE RADIOS.....	j	5-4 Jammer code.....	p. 5-3
PROGRAMS.....	j	5-5 Preamble code.....	p. 5-4
COPYRIGHT.....	j	5-6 End of message code.....	p. 5-4
TABLE OF CONTENTS.....	ii		
1. WHAT IS THE CI-V SYSTEM?	pgs. 1-1~1-2	6. SPECIAL CHANNEL NUMBER AND MODE DATA	pgs. 6-1~6-2
1-1 Advanced remote control.....	p. 1-1	6-1 What are special memory channel numbers?	p. 6-1
1-2 Features.....	p. 1-1	6-2 Scan edge channels for the IC-R9000	p. 6-1
1-3 History of the CI-V System.....	p. 1-1	6-3 Scan edge channels for the IC-R7100	p. 6-1
1-4 Required equipment	p. 1-2	6-4 Other special memory channel numbers.....	p. 6-1
1-5 How to prevent RFI	p. 1-2	6-5 Special memory channel access example	p. 6-1
1-6 CSMA/CD System	p. 1-2	6-6 Mode and IF passband width tables	p. 6-2
1-7 Transceivers and receivers	p. 1-2		
1-8 Data transmission system.....	p. 1-2		
1-9 Decimal and hexadecimal values.....	p. 1-2		
1-10 BCD code	p. 1-2		
2. PRE-SETTINGS	pgs. 2-1~2-3	7. COMMAND DESCRIPTION	pgs. 7-1~ 7-24
2-1 Pre-setting outline.....	p. 2-1	7-1 Transceive commands.....	p. 7-1
2-2 Changing CI-IV to CI-V.....	p. 2-1	7-2 Upper/lower-edge frequency readout command.....	p. 7-3
2-3 Baud rate for radios.....	p. 2-1	7-3 Operating frequency, mode readout commands	p. 7-4
2-4 Baud rate modification	p. 2-1	7-4 Operating frequency, mode writing commands.....	p. 7-5
2-5 Address numbers for each radio.....	p. 2-2	7-5 VFO selection command	p. 7-6
2-6 Address number modification.....	p. 2-2	7-6 Front window selection command	p. 7-7
2-7 Personal computer conditions.....	p. 2-2	7-7 Memory channel commands.....	p. 7-8
2-8 Address number for the controller.....	p. 2-2	7-8 Offset frequency commands.....	p. 7-11
2-9 What is the transceive function?	p. 2-3	7-9 Scan start/stop command	p. 7-12
2-10 Transceive function ON/OFF	p. 2-3	7-10 Scan condition command.....	p. 7-13
2-11 Operating frequency data length.....	p. 2-3	7-11 Sub commands for command 0EH	p. 7-14
 		7-12 Basic window scan command	p. 7-15
3. CONNECTIONS	p. 3-1	7-13 Advanced window scan start/stop command.....	p. 7-16
3-1 Connection outline	p. 3-1	7-14 Split and duplex command	p. 7-18
3-2 RS-232C cable connection.....	p. 3-1	7-15 Tuning step command.....	p. 7-19
3-3 Mini-plug cable connection.....	p. 3-1	7-16 Other commands.....	p. 7-20
3-4 DC power supply connection	p. 3-1		
4. COMMAND TABLES.....	pgs. 4-1~4-3		

1-1 Advanced remote control

The CI-V System enables you to control radio functions while your radio is not at hand. Instead of the radio's front panel, you can use a personal computer.

Most recent Icom radios have a CPU, also known as a microprocessor. Each CPU is programmed to communicate with an external remote controller or CPUs in other radios. In the CI-V System, the remote controller means a personal computer connected via an optional CT-17 CI-V LEVEL CONVERTER.

You can utilize the state-of-the-art CI-V System to change operating frequency or mode, to activate a scan function, and more while you are away from your radio. What a convenient system!

After you have typed in a computer command, the computer converts the command to signals which another radio's CPU accepts. Signals conform to a pattern for communication between computer and radio.

The following sections describe how to control your radio with your computer.

1-2 Features

The CI-V System allows easy computer control of a variety of radios. Listed below are only some of its sophisticated features.

- Remote control for up to 4 radios. (Section 3-1)
- Operating frequency selection. (Section 7-4)
- Operating mode selection. (Section 7-4)
- Memory channel selection. (Section 7-7)
- Memory writing. (Section 7-7)
- Scan control. (Sections 7-9-7-13)
- Automatic operating frequency and mode data transfer between radios. (Sections 2-9, 7-1)
- Serial data communication based on the CSMA/CD (Carrier Sense Multiple Access with Collision Detection) System. (Section 1-6)

1-3 History of the CI-V System

The CI-V System is Icom's 5th communication interface product. Either the CI-IV or CI-V System have been installed in recent HF, all mode and almost all receivers. (Section 2-2)

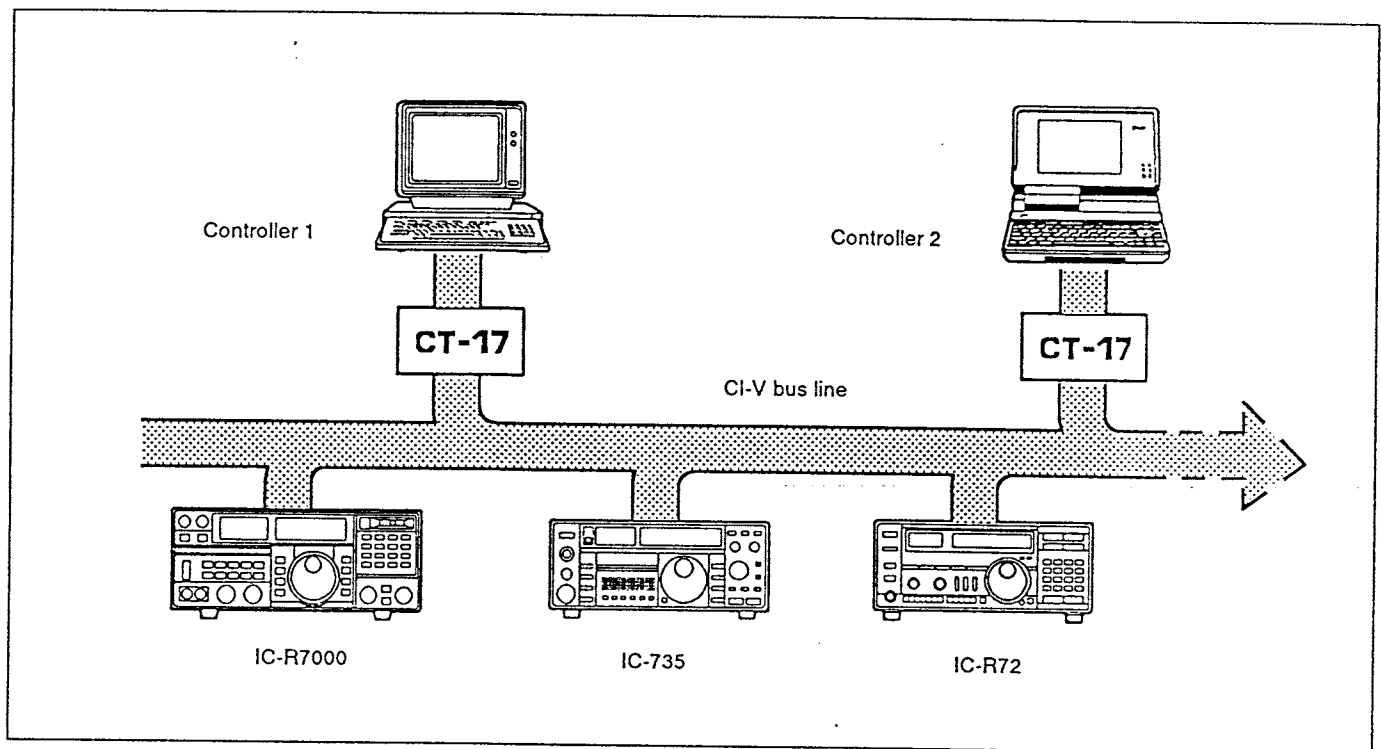

Fig. 1-1

1-4 Required equipment

To control CI-V radios, a personal computer equipped with an EIA standard RS-232C I/O port is required.

Icom offers the following options for the CI-V System.

■ CT-17 CI-V LEVEL CONVERTER

Using the CT-17, CI-V radios can be externally controlled with a personal computer. Up to 4 CI-V radios can be connected to the CT-17. (Section 3-1)

■ UX-14 CI-IV/CI-V CONVERTER

Required only for radios equipped with the CI-IV System. The UX-14 allows a CI-IV radio to utilize the CI-V System. (Section 2-2)

1-5 How to prevent RFI

Computer equipment that is set near a radio may cause RFI (Radio Frequency Interference). Following are a few ways to prevent RFI:

- Keep well matched antennas away from the computer.
- Keep coaxial cables away from the computer.
- Use an AC line filter for a computer AC power cable.
- Use the shortest and heaviest possible gauge wire or strap for computer grounding.

1-6 CSMA/CD System

The CSMA/CD (Carrier Sense Multiple Access with Collision Detection) System is a way to manage the CI-V System. The system keeps the CI-V bus line as free as possible of useless messages and raises bus line efficiency to over 90%.

During data transmission, the radio which is transmitting a message monitors the CI-V bus line simultaneously. If message collisions are detected, the radio halts the message transmission. After waiting for a programmed period of time, the radio sends the previous message again. (Section 5-4)

1-7 Transceivers and receivers

In this manual, the word "radio" refer to both transceivers and receivers.

1-8 Data transmission system

The CT-17 and each radio exchange serial information using NRZ (Non Return to Zero) format. Fig. 1-2 below shows an example of 1-byte data composition.

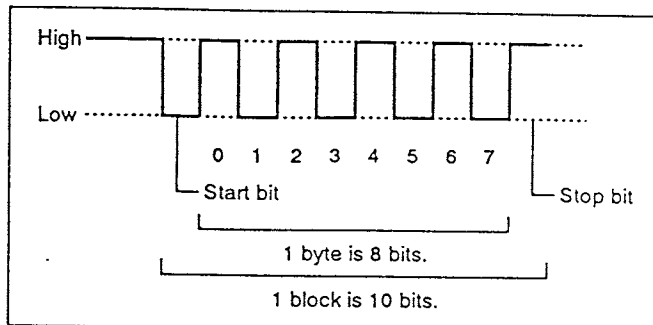

Fig. 1-2

1-9 Decimal and hexadecimal values

In this manual, a value is usually base 16, a hexadecimal value.

Hexadecimal value	0H	1H	2H	3H	4H	5H	6H	7H
Decimal value	0	1	2	3	4	5	6	7
Hexadecimal value	8H	9H	AH	BH	CH	DH	EH	FH
Decimal value	8	9	10	11	12	13	14	15

Table 1-1

1-10 BCD code

For frequency data, the memory channel number and every other data **MUST** be specified in BCD (Binary Coded Decimal) code. Refer to Table 1-3 below.

[Example]

To select memory channel 15, specify memory channel number data as 15H.

Decimal value	Corresponding BCD code	
	Binary code	Hexadecimal code
9	0000 1001	09H
10	0001 0000	10H
15	0001 0101	15H
26	0010 0110	26H
87	1000 0111	87H

Table 1-2

2-1 Pre-setting outline

WARNING: DISCONNECT the AC and DC power cables from the radios before performing any internal work.

Following is the pre-setting outline for the CI-V radios, CT-17 and your personal computer. Refer to Section 2-2-2-11 for condition setting. Refer to Section 3-1-3-4 for connection.

- 1) Set the baud rate, address and transceive function condition for all radios.
 - For some radios, these settings can be performed after power is turned ON.
- 2) Connect the [REMOTE] jack on each radio to the CT-17.
- 3) Connect the computer to the CT-17 using a suitable RS-232C straight cable.
- 4) Connect a 9-15 V DC power source to the CT-17.
- 5) Turn ON your radios and personal computer.
- 6) Set the personal computer conditions.

2-2 Changing CI-IV to CI-V

To control a CI-IV radio remotely with the CI-V System, an optional UX-14 CI-IV/CI-V CONVERTER **MUST** be installed. Refer to Table 2-1 below.

2-3 Baud rate for radios

■ For a CI-V radio

The Icom standard baud rate of 1200 bps is specified before shipping.

■ For a CI-IV radio

Specify a radio baud rate. Refer to the UX-14 instruction manual.

2-4 Baud rate modification

If required, modify the radio baud rate. Selectable baud rates and setting methods differ according to radios. Refer to the instruction manual of each radio or UX-14.

NOTE: Each radio's baud rate **MUST** be equal to the computer's baud rate. (Section 2-7)

	CI-IV System	CI-V System
HF transceivers	IC-751, IC-751A	IC-725, IC-726, IC-728, IC-729, IC-735, IC-737, IC-761, IC-765
Receivers	IC-R71A/E/D	IC-R72, IC-R7000, IC-R7100, IC-R9000
28/50 MHz transceivers	—	IC-575A/H
144 MHz transceivers	IC-271A/E/H	IC-275A/E/H
220 MHz transceiver	—	IC-375A
430 MHz transceivers	IC-471A/E/H	IC-475A/E/H
1200 MHz transceivers	IC-1271A/E	IC-1275A/E
Multi band transceiver	—	IC-970A/E/H

Table 2-1

2-5 Address number for each radio

To distinguish equipment, each radio has its own address in hexadecimal code.

■ For a CI-V radio

An Icom standard address number was specified before shipping. Refer to Table 2-2 below.

■ For a CI-IV radio

Specify an Icom standard address number. Refer to the UX-14 instruction manual and Table 2-2 below.

2-6 Address number modification

If required, up to 4 radios of the same model can be connected to the CT-17. However, a different address number **MUST** be specified for each radio.

Address numbers 01H-7FH are allocated, but the selectable range varies according to radios.

Setting methods differ according to radios. Refer to the instruction manual of each radio or the UX-14.

NOTE: DO NOT specify address number 00H, E0H or F0H-FFH for a radio address. These address numbers are already reserved for the controller and other functions.

2-7 Personal computer conditions

Specify RS-232C port conditions (protocol) on your computer as follows:

Baud rate	1200 bps
Data bit length	8 bits
Parity check	No parity
Start bit length	1 bit
Stop bit length	1 bit
System	Full duplex
X parameter	Non effective
S parameter	Non effective

Table 2-3

NOTE: The Icom standard baud rate of 1200 bps is specified for each radio before shipping. (Section 2-4)

2-8 Address number for the controller

Specify the controller's address in hexadecimal code.

The Icom standard address number for the controller is E0H.

Radio	Address	Radio	Address	Radio	Address	Radio	Address
IC-735	04H	IC-R71A/E/D	1AH	IC-725	28H	—	36H
IC-R7000	08H	IC-751A	1CH	IC-R9000	2AH	IC-728	38H
IC-275A/E/H	10H	IC-761	1EH	IC-765	2CH	IC-729	3AH
IC-375A	12H	IC-271A/E/H	20H	IC-970A/E/H	2EH	IC-737	3CH
IC-475A/E/H	14H	IC-471A/E/H	22H	IC-726	30H	—	3EH
IC-575A/H	16H	IC-1271A/E	24H	IC-R72	32H	—	40H
IC-1275A/E	18H	IC-781	26H	IC-R7100	34H	Controller	E0H

Table 2-2

— : Not yet assigned for any radio at the time of printing.

2-9 What is the transceive function?

When the transceive function is ON, any change in the operating frequency or mode on a radio is automatically transferred to other radios.

[Example]

In Fig. 2-1 below, when the operating frequency of the IC-735 is changed, the IC-R72 follows the IC-735. This is because the operating frequency range of the IC-735 corresponds to that of the IC-R72.

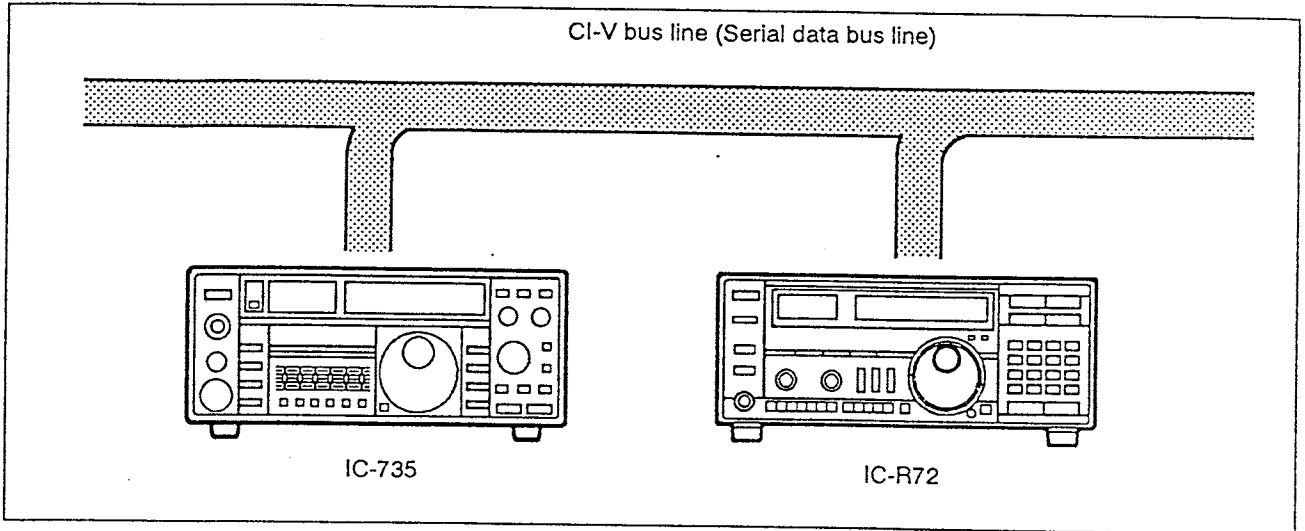

Fig. 2-1

2-10 Transceive function ON/OFF

The transceive function can be set as ON (effective), or OFF (non-effective), for each radio.

Setting methods differ according to radios. Refer to the instruction manual of each radio or the UX-14.

Transceive function ON (effective) was specified before shipping.

2-11 Operating frequency data length

Radios	Operating frequency data length
IC-735	4 bytes (fixed)
Other HF transceivers, IC-R71A/E/D, IC-R72, IC-R7100, IC-R9000	5 bytes *1 or 4 bytes *2
Other radios	5 bytes (fixed)

Table 2-5

*1: For these radios, the frequency data length was specified at 5 bytes before shipping.

*2: Specify the frequency data length at 4 bytes only for operating the transceive function with the IC-735. Setting methods differ according to radios. Refer to the instruction manual of each radio or the UX-14.

3-1 Connection outline

After performing internal settings for each radio, connect each radio, the CT-17 and your computer.

CAUTION: DISCONNECT the AC or DC power cable from each radio, the computer and the DC power supply for the CT-17 before connection.

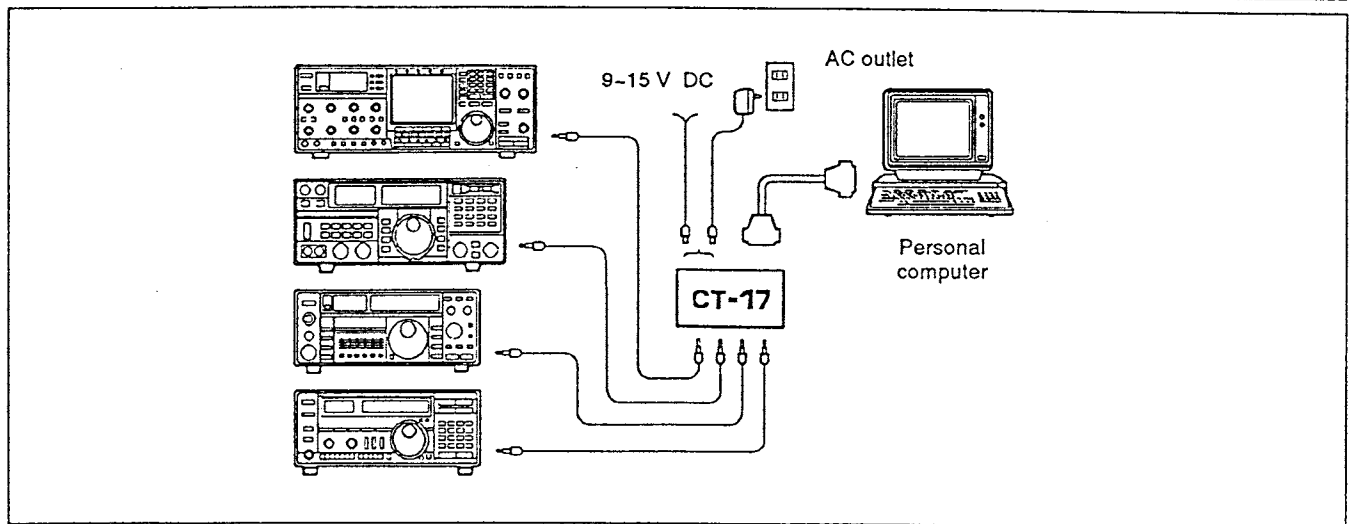

Fig. 3-1

3-2 RS-232C cable connection

According to the RS-232C socket on your computer, connect a suitable RS-232C cable.

■ **For a 25-pin RS-232C socket**

Connect the RS-232C connector on the CT-17 to your computer using the supplied OPC-159 RS-232C CABLE.

Inch-type screws are attached to the supplied RS-232C cable. If the RS-232C socket of your computer uses meter-type screws, the supplied meter-type screws **MUST** be used.

■ **For a non 25-pin RS-232C socket**

Use an RS-232C straight cable equipped with a suitable connector for your computer on one end and a 25-pin connector on the other end. Or, use a suitable RS-232C straight adapter between the supplied OPC-159 RS-232C CABLE and your computer.

This kind of RS-232C straight cable and adapter are commonly used to connect between a computer and modem or TNC (Terminal Node Controller) for packet radio. Consult your computer dealer.

NOTE: An RS-232C cross (reverse) cable or adapter **CANNOT** be used.

3-3 Mini-plug cable connection

Connect the [REMOTE] jack on the radio to either the [CI-V REMOTE] jacks on the CT-17 using the supplied OPC-017A MINI-PLUG CABLE.

- The CT-17 accepts up to 4 radios.
- To connect 3 or 4 radios, additional OPC-017A **MUST** be purchased.

3-4 DC power supply connection

After all other connections, connect a 9-15 V DC power source to the [9-15V DC IN] jack on the CT-17 using the supplied OPC-012 DC POWER CABLE.

- The power indicator on the CT-17 lights up in red.
- An optional BC-25U/E, BC-26E or BC-27 WALL CHARGER also can be used.

Polarity of the OPC-012 is as follows:

White: + Black: -

CONVENIENT: If a radio is equipped with an ACC connector, 13.8 V DC may be available from the connector. Refer to the radio's instruction manual.

Command		Operation	IC-735	IC-R7000	IC-575	IC-751	IC-271	IC-725
Sub	IC-275				IC-751A	IC-471	IC-726	
					IC-375A	IC-761	IC-1271	IC-728
					IC-475	IC-R71		IC-729
					IC-1275			
00	—	Transfers operating frequency data.	Yes*1	Yes	Yes	Yes	Yes	Yes
01	md ; pd	Transfers operating mode data.	Yes*2	Yes	Yes	Yes	Yes	Yes
02	—	Reads upper/lower frequency data.	Yes	Yes	Yes	Yes	Yes	Yes
03	—	Reads operating frequency data.	Yes*1	Yes	Yes	Yes	Yes	Yes
04	—	Reads operating mode data.	Yes*2	Yes	Yes	Yes	Yes	Yes
05	—	Writes operating frequency data.	Yes*1	Yes	Yes	Yes	Yes	Yes
06	md ; pd	Writes operating mode data.	Yes*2	Yes	Yes	Yes	Yes	Yes
07	—	Selects VFO mode.	Yes	—	Yes	Yes	Yes	Yes
	00	Selects VFO A.	Yes	—	Yes	—	—	Yes
	01	Selects VFO B.	Yes	—	Yes	—	—	Yes
	A0	VFO A = VFO B	—	—	—	—	—	Yes
08	—	Selects MEMORY mode.	Yes	Yes	Yes	Yes	Yes	Yes
	mc	Selects memory channel.	Yes	Yes	Yes	Yes	Yes	Yes
09	—	Memory write.	Yes	Yes	Yes	Yes	Yes	Yes
0A	—	Memory channel → VFO.	Yes	—	Yes	Yes	Yes	Yes
0B	—	Memory clear.	—	Yes	Yes	—	—	Yes
0C	—	Reads offset freq.	—	—	Yes	—	Yes	—
0D	—	Writes offset freq.	—	—	Yes	—	Yes	—
0E	00	Stops scan or stops window scan.	—	—	Yes	—	—	Yes
	01	Programmed scan or memory scan starts.	—	—	Yes	—	—	Yes
0F	00	Cancels split frequency operation.	—	—	—	—	—	Yes
	01	Selects split frequency operation.	—	—	—	—	—	Yes

*1: Only for the IC-735, frequency data length is 4 bytes. For other radios, frequency data length is 5 bytes. Refer to Sections 2-10 and 2-11.

*2: The IC-735 CANNOT accept mode data with IF passband width data.

Table 4-1

Command		Operation	IC-781	IC-R9000	IC-765	IC-970	IC-R72	IC-R7100	IC-737
	Sub								
00	—	Transfers operating frequency data.	Yes	Yes	Yes	Yes	Yes	Yes	Yes
01	md pd	Transfers operating mode data.	Yes	Yes	Yes	Yes	Yes	Yes	Yes
02	—	Reads upper/lower frequency data.	Yes	Yes	Yes	Yes	Yes	Yes	Yes
03	—	Reads operating frequency data.	Yes	Yes	Yes	Yes	Yes	Yes	Yes
04	—	Reads operating mode data.	Yes	Yes	Yes	Yes	Yes	Yes	Yes
05	—	Writes operating frequency data.	Yes	Yes	Yes	Yes	Yes	Yes	Yes
06	md pd	Writes operating mode data.	Yes	Yes	Yes	Yes	Yes	Yes	Yes
07	—	Selects VFO mode.	Yes	—	Yes	Yes	Yes	—	Yes
	00	Selects VFO A.	Yes	—	Yes	Yes	—	—	Yes
	01	Selects VFO B.	Yes	—	Yes	Yes	—	—	Yes
	A0	VFO A = VFO B.	Yes	—	Yes	Yes	—	—	Yes
	B0	VFO A ↔ VFO B. *1	Yes	—	—	Yes	—	—	—
	C0	Turns dual watch OFF.	Yes	—	—	—	—	—	—
	C1	Turns dual watch ON.	Yes	—	—	—	—	—	—
	D0	Accesses MAIN band.	—	—	—	Yes	—	—	—
	D1	Accesses SUB band.	—	—	—	Yes	—	—	—
	E0 wn	Selects the front window.	—	—	—	—	—	Yes	—
08	—	Selects MEMORY mode.	Yes	Yes	Yes	Yes	Yes	Yes	Yes
	mc	Selects memory channel.	Yes	Yes	Yes	Yes	Yes	Yes	Yes
09	—	Memory write.	Yes	Yes	Yes	Yes	Yes	Yes	Yes
0A	—	Memory channel → VFO.	Yes	—	Yes	Yes	Yes	—	Yes
0B	—	Memory clear.	Yes	Yes	Yes	Yes	Yes	Yes	—
0C	—	Reads offset freq.	—	—	—	Yes	—	—	—
0D	—	Writes offset freq.	—	—	—	Yes	—	—	—
0E	00	Stops scan or stops window scan.	Yes	Yes	Yes	Yes	Yes	Yes*2	Yes
	01	Programmed scan or memory scan starts.	Yes	—	Yes	Yes	Yes	—	Yes
	02	Programmed scan starts.	Yes	Yes	—	—	Yes	Yes*2	—
	03	Δ f scan starts.	Yes	Yes	—	—	—	—	—
	04	Auto memory write scan starts.	—	Yes	—	—	Yes	Yes*2	—
	12	Fine programmed scan starts.	Yes	—	—	—	—	—	—
	13	Fine Δ f scan starts.	Yes	—	—	—	—	—	—
	22	Memory scan starts.	Yes	Yes	—	—	Yes	Yes*2	—
	23	Selected number memory scan starts.	Yes	Yes	—	—	Yes	Yes*2	—
	24	Selected mode memory scan starts.	—	Yes	—	—	—	Yes*2	—
	42	Priority scan or window scan starts.	—	Priority	—	—	—	Window*2	—
	A0	Unfixes the center frequency for Δ f scan.	Yes	Yes	—	—	—	—	—
	AA	Fixes the center frequency for Δ f scan.	Yes	Yes	—	—	—	—	—
	A1	Sets Δ f frequency width of ± 2.5 kHz.	Yes	Yes	—	—	—	—	—
	A2	Sets Δ f frequency width of ± 5 kHz.	Yes	Yes	—	—	—	—	—
	A3	Sets Δ f frequency width of ± 10 kHz.	Yes	Yes	—	—	—	—	—
A4	Sets Δ f frequency width of ± 20 kHz.	Yes	Yes	—	—	—	—	—	
A5	Sets Δ f frequency width of ± 50 kHz.	Yes	Yes	—	—	—	—	—	

*1: For the IC-970, MAIN ↔ SUB.

*2: For advanced window scan, a window number MUST be specified after the sub command. Refer to Section 7-13.

Table 4-2

Command		Operation	IC-781	IC-R9000	IC-765	IC-970	IC-R72	IC-R7100	IC-737
	Sub								
0E	B0	Sets the selected number as non effective for a memory channel.	Yes	Yes	—	—	Yes	Yes	—
	B1	Sets the selected number as effective for a memory channel.	Yes	Yes	—	—	Yes	Yes	—
	B2	Sets the scan number for a selected number memory scan.	Yes	Yes	—	—	—	Yes*1	—
	C0	Turns the VSC function OFF.	—	Yes	—	—	—	Yes	—
	C1	Turns the VSC function ON.	—	Yes	—	—	—	Yes	—
	D0	Selects scan resume condition [∞]. *2	—	Yes	—	—	—	Yes	—
	D1	Selects scan resume condition [OFF]. *2	—	Yes	—	—	—	Yes	—
	D2	Selects scan resume condition [B]. *2	—	Yes	—	—	—	—	—
0F	00	00	00	00	00	00	00	00	00
	01	01	01	01	01	01	01	01	01
	10	10	10	10	10	10	10	10	10
	11	11	11	11	11	11	11	11	11
	12	12	12	12	12	12	12	12	12
10	00	Selects the minimum tuning step.	—	10 Hz	—	—	10 Hz	100 Hz	10 Hz
	01	Selects tuning step 1.	—	100 Hz	—	—	1 kHz	1 kHz	1 kHz
	02	Selects tuning step 2.	—	1 kHz	—	—	2 kHz	5 kHz	2 kHz
	03	Selects tuning step 3.	—	5 kHz	—	—	3 kHz	10 kHz	3 kHz
	04	Selects tuning step 4.	—	9 kHz	—	—	4 kHz	12.5 kHz	4 kHz
	05	Selects tuning step 5.	—	10 kHz	—	—	5 kHz	20 kHz	5 kHz
	06	Selects tuning step 6.	—	12.5 kHz	—	—	6 kHz	25 kHz	6 kHz
	07	Selects tuning step 7.	—	20 kHz	—	—	7 kHz	100 kHz	7 kHz
	08	Selects tuning step 8.	—	25 kHz	—	—	8 kHz	—	8 kHz
	09	Selects tuning step 9.	—	100 kHz	—	—	9 kHz	—	9 kHz
	10	Selects tuning step 10.	—	—	—	—	10 kHz	—	10 kHz
11	00	Attenuator OFF.	—	Yes	—	—	—	Yes	—
	10	Selects a 10 dB attenuator.	—	Yes	—	—	—	—	—
	20	Selects a 20 dB attenuator.	—	Yes	—	—	—	Yes	—
	30	Selects a 30 dB attenuator.	—	Yes	—	—	—	—	—
12	00	Turns the antenna input OFF.*3	—	Yes	—	—	—	—	Yes
	01	Turns the antenna input ON.*4	—	Yes	—	—	—	—	Yes
13	00	Announces all data.*5	—	Yes	—	—	Yes	Yes	—
	01	Announces frequency data only.*5	—	Yes	—	—	Yes	Yes	—
14	sc gd	Selects the AF, RF gain and squelch.*6	—	Yes	—	—	—	Yes	—
15	01	Reads out squelch status.	—	Yes	—	—	Yes	Yes	—
	02	Reads out signal strength.	—	Yes	—	—	—	Yes	—

*1: For advanced window scan, a window number MUST be specified after the sub command. Refer to Section 2-10.
 *2: Refer to the IC-R9000 instruction manual p. 46 or the IC-R7100 instruction manual p. 22 for details.
 *3: For the IC-737, selects the [ANT 1] connector.
 *4: For the IC-737, selects the [ANT 2] connector.
 *5: An optional UT-36 is required.
 *6: For the IC-R7100, only AF gain level can be controlled via the CI-V System.

Table 4-3

5-1 Basic message format

■ Controller → radio (command message)

The controller transmits a command message to a radio in the following data format.

The data format differs according to command numbers. A data area is added for some commands.

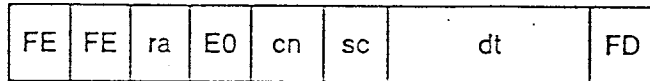

→ Sent left to right.

FE Preamble code
FEH must be transmitted 2 times for data synchronization.

ra Receive address
Specify a radio's address in hexadecimal code. (Section 2-5)

E0 Transmit address
Specify the controller's address, E0H. (Section 2-8)

cn Command number
Specify a command number in hexadecimal code. (Section 4)

sc Sub command number
For some commands, a sub command number MUST be specified in hexadecimal code. (Section 4)

dt Data area
For some commands, additional data MUST be specified in BCD code. (Section 1-10)

For some commands, a data area is not to be added.

FD End of message code
Specify FDH at the end of the message.

■ Radio → controller

When a command message is received, the radio transmits the data message, the OK message or NG message.

(1) Data message

When the controller requests sending of the operating frequency data, operating mode data, etc., the radio transmits the requested data in the following data format.

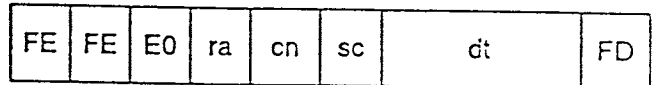

→ Sent left to right.

FE Preamble code
The radio automatically specifies FEH 2 times for data synchronization.

E0 Receive address
The radio automatically specifies the controller's address, E0H.

ra Transmit address
The radio automatically specifies its address in hexadecimal code.

cn Command number
The radio automatically specifies the received command number in hexadecimal code.

sc Sub command number
The radio automatically specifies the received sub command number in hexadecimal code.

dt Data area
The radio sends back requested data for the following commands in BCD code. (Section 1-10)

Command 02H (Section 7-2)

Command 03H (Section 7-3)

Command 04H (Section 7-3)

Command 0CH (Section 7-8)

Command 15H (Section 7-16)

FD End of message code
The radio automatically specifies FDH at the end of the message.

(2) OK message

The OK message means that the radio has received a correct command message from the controller and has performed the specified operation.

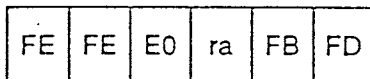

→ Sent left to right.

- | | |
|----|---|
| FE | Preamble code
The radio automatically specifies FEH 2 times for data synchronization. |
| E0 | Receive address
The radio automatically specifies the controller's address, E0H. |
| ra | Transmit address
The radio automatically specifies its address in hexadecimal code. |
| FB | OK code
The radio automatically specifies the OK code, FBH. |
| FD | End of message code
The radio automatically specifies FDH at the end of the message. |

Under the following condition, the radio does not transmit the OK message even when the correct command message has been received:

- Command 00H or 01H has been received. (Sections 2-9, 7-1)
- When the radio has transmitted requested data.

(3) NG message

The NG message means that the radio has received a message, but it could not perform the specified operation.

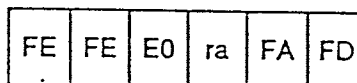

→ Sent left to right.

- | | |
|----|---|
| FE | Preamble code
The radio automatically specifies FEH 2 times for data synchronization. |
| E0 | Receive address
The radio automatically specifies the controller's address, E0H. |
| ra | Transmit address
The radio automatically specifies its address in hexadecimal code. |
| FA | NG code
The radio automatically specifies the NG code, FAH. |
| FD | End of message code
The radio automatically specifies FDH at the end of the message. |

Under the following conditions, the radio transmits the NG message:

- Command 00H or 01H has been received. (Sections 2-9, 7-1)
- Undefined command or sub command is received.
- Specified frequency range or mode does not correspond to the radio's operating frequency range or mode.
- The radio is not equipped with the specified function.
- The radio is not equipped with the specified memory channel.
- A blank channel has been specified for command message 0AH. (Section 7-7)

5-1 Basic message format

■ Controller → radio (command message)

The controller transmits a command message to a radio in the following data format.

The data format differs according to command numbers. A data area is added for some commands.

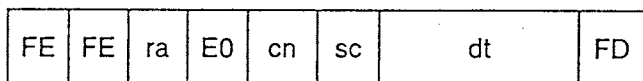

→ Sent left to right.

FE

Preamble code

FEH must be transmitted 2 times for data synchronization.

ra

Receive address

Specify a radio's address in hexadecimal code. (Section 2-5)

E0

Transmit address

Specify the controller's address, E0H. (Section 2-8)

cn

Command number

Specify a command number in hexadecimal code. (Section 4)

sc

Sub command number

For some commands, a sub command number **MUST** be specified in hexadecimal code. (Section 4)

dt

Data area

For some commands, additional data **MUST** be specified in BCD code. (Section 1-10)

For some commands, a data area is not to be added.

FD

End of message code

Specify FDH at the end of the message.

■ Radio → controller

When a command message is received, the radio transmits the data message, the OK message or NG message.

(1) Data message

When the controller requests sending of the operating frequency data, operating mode data, etc., the radio transmits the requested data in the following data format.

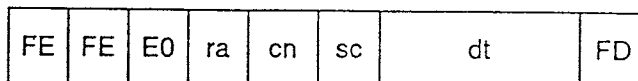

→ Sent left to right.

FE

Preamble code

The radio automatically specifies FEH 2 times for data synchronization.

E0

Receive address

The radio automatically specifies the controller's address, E0H.

ra

Transmit address

The radio automatically specifies its address in hexadecimal code.

cn

Command number

The radio automatically specifies the received command number in hexadecimal code.

sc

Sub command number

The radio automatically specifies the received sub command number in hexadecimal code.

dt

Data area

The radio sends back requested data for the following commands in BCD code. (Section 1-10)

Command 02H (Section 7-2)

Command 03H (Section 7-3)

Command 04H (Section 7-3)

Command 0CH (Section 7-8)

Command 15H (Section 7-16)

FD

End of message code

The radio automatically specifies FDH at the end of the message.

(2) OK message

The OK message means that the radio has received a correct command message from the controller and has performed the specified operation.

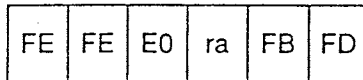

→ Sent left to right.

- | | |
|----|---|
| FE | Preamble code
The radio automatically specifies FEH 2 times for data synchronization. |
| E0 | Receive address
The radio automatically specifies the controller's address, E0H. |
| ra | Transmit address
The radio automatically specifies its address in hexadecimal code. |
| FB | OK code
The radio automatically specifies the OK code, FBH. |
| FD | End of message code
The radio automatically specifies FDH at the end of the message. |

Under the following condition, the radio does not transmit the OK message even when the correct command message has been received:

- Command 00H or 01H has been received. (Sections 2-9, 7-1)
- When the radio has transmitted requested data.

(3) NG message

The NG message means that the radio has received a message, but it could not perform the specified operation.

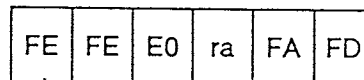

→ Sent left to right.

- | | |
|----|---|
| FE | Preamble code
The radio automatically specifies FEH 2 times for data synchronization. |
| E0 | Receive address
The radio automatically specifies the controller's address, E0H. |
| ra | Transmit address
The radio automatically specifies its address in hexadecimal code. |
| FA | NG code
The radio automatically specifies the NG code, FAH. |
| FD | End of message code
The radio automatically specifies FDH at the end of the message. |

Under the following conditions, the radio transmits the NG message:

- Command 00H or 01H has been received. (Sections 2-9, 7-1)
- Undefined command or sub command is received.
- Specified frequency range or mode does not correspond to the radio's operating frequency range or mode.
- The radio is not equipped with the specified function.
- The radio is not equipped with the specified memory channel.
- A blank channel has been specified for command message 0AH. (Section 7-7)

5-2 Frequency data format

For command 00H, 02H or 05H, specify frequency data according to the following format. For command 02H or 03H, each transceiver transmits according to the same format.

The operating frequency data length is 5 bytes* and each byte is specified in BCD code. (Section 1-10)

*For the IC-735, 4 bytes.

■ Frequency data length

IC-735 only	4 bytes. Specify the 10 MHz-1 Hz digits.
Other radios	5 bytes. Specify the 1 GHz-1 Hz digits. Only for transceive operation with the IC-735, select 4 bytes, and specify the 10 MHz-1 Hz digits.

Table 5-1

Some radios may not display the 10 Hz and 1 Hz digits.

Each radio ignores the frequency data below the minimum tuning step.

[Example]

When the operating frequency is 145.123450 MHz, the 1st byte, 50H refers to the 10 Hz and 1 Hz digits. The 2nd byte, 34H refers to the 1 kHz and 100 Hz digits.

For the IC-735, the 5th byte **CANNOT** be specified.

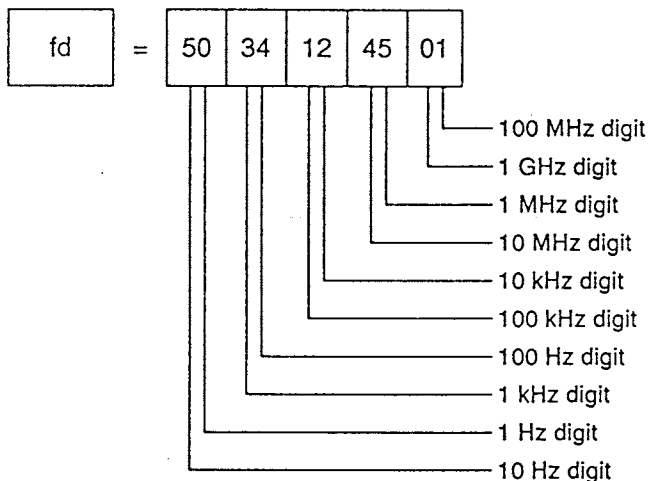

Fig. 5-1

5-3 Memory blank code

A memory channel without contents is called a blank channel. When a blank channel is specified via the controller with command 03H, 04H or 0CH, the radio transmits the blank code, FFH.

■ Radio → controller

FE	FE	E0	ra	cn	FF	FD
----	----	----	----	----	----	----

→ Sent left to right.

The IC-761 or other radios equipped with the CI-IV System transmit previous memory contents, even though the memory channel is a blank channel. This is because blank channels have previous contents.

5-4 Jammer code

The jammer code, FCH, prevents a message collision among radios and the controller. (Section 1-6)

■ Message transmitting radio

During message transmission, a radio which is transmitting receives a transmitted message from itself to detect a message collision.

If a message collision with another radio is detected, the radio halts message transmission, and checks that no other messages are transmitted on the CI-V bus line.

When no other message is transmitted, the radio transmits the jammer code, FCH, 5 times as below.

FC	FC	FC	FC	FC
----	----	----	----	----

→ Sent left to right.

After jammer code transmission, the radio checks that no other message is being transmitted on the CI-V bus line, and transmits the previous message again.

■ Message receiving radio

When the jammer code, FCH, is received during command message receiving, the radio cancels the current command message and waits for the next command message.

5-5 Preamble code

From the controller, FEH **MUST** be transmitted 2 times at the beginning of the message for data synchronization.

Each radio automatically transmits FEH 2 times at the beginning of the message for data synchronization.

5-6 End of message code

From the controller, FDH **MUST** be transmitted at the end of the message.

Each radio automatically transmits FDH at the end of message.

6-1 What are special memory channel numbers?

Some radios have special memory channel numbers to specify a call channel, scan edge channels etc.

By specifying a special memory channel number, a call channel or scan edge channel can be specified in the same way as ordinary memory channels. (Section 7-7)

6-2 Scan edge channels for the IC-R9000

Group 0	0P1	1000	Group 5	5P1	1010
	0P2	1001		5P2	1011
Group 1	1P1	1002	Group 6	6P1	1012
	1P2	1003		6P2	1013
Group 2	2P1	1004	Group 7	7P1	1014
	2P2	1005		7P2	1015
Group 3	3P1	1006	Group 8	8P1	1016
	3P2	1007		8P2	1017
Group 4	4P1	1008	Group 9	9P1	1018
	4P2	1009		9P2	1019

Table 6-1

6-3 Scan edge channels for the IC-R7100

Group 0	0P1	0900	Group 5	5P1	0910
	0P2	0901		5P2	0911
Group 1	1P1	0902	Group 6	6P1	0912
	1P2	0903		6P2	0913
Group 2	2P1	0904	Group 7	7P1	0914
	2P2	0905		7P2	0915
Group 3	3P1	0906	Group 8	8P1	0916
	3P2	0907		8P2	0917
Group 4	4P1	0908	Group 9	9P1	0918
	4P2	0909		9P2	0919

Table 6-2

6-4 Other special memory channel numbers

	Scan edge		Call channel
	P1	P2	
IC-725, IC-726, IC-737, IC-761, IC-765, IC-781, IC-575A/H, IC-R72	0100	0101	—
IC-275A/E/H, IC-375A, IC-475A/E/H, IC-1275A/E, IC-970A/E/H*	0100	0101	0102

Table 6-3

*For the IC-970A/E/H, the call channel and scan edge channels P1 and P2 in the selected band are accessible.

	Scan edge		Call channel
	25	26	
IC-728, IC-729	0025	0026	—

Table 6-4

6-5 Special memory channel access example

For the IC-R9000, to recall scan edge channel 9P2, send command 08H in the data format below.

FE	FE	2A	E0	2A	10	19	FD
----	----	----	----	----	----	----	----

- 2A** Receive address
Specify the IC-R9000's address, 2AH.
- E0** Transmit address
Specify the controller's address, E0H.
- 08** Command number
Specify a command number, 08H, for memory channel recall. (Section 7-7)
- 10** Special memory channel number
Specify special memory channel number 1019 in BCD code to recall scan edge channel 9P2 in the IC-R9000. (Section 1-10)
- 19**

6-6 Mode and IF passband width tables

	Mode data
LSB	00
USB	01
AM	02
CW	03
RTTY (FSK)	04
FM	05
Wide FM	06
SSB*	0500

Table 6-5

*For the IC-R7000 only.

For the IC-781, IC-R9000 and IC-R7000, IF passband width is selectable via the CI-V System. Other radios are not equipped with this capability.

	Mode	Mode data	IF passband width data		
			Wide	Medlum	Narrow
IC-781	LSB	00	01	—	02
	USB	01	01	—	02
	AM	02	01	—	02
	CW	03	01	—	02
	RTTY	04	01	—	02
	FM	05	01	—	02
IC-R9000	LSB	00	01	02	03
	USB	01	01	02	03
	AM	02	01	02	03
	CW	03	01	02	03
	RTTY	04	01	02	03
	FM	05	01	02	03
	Wide-FM	06	01*	02*	03*
IC-R7000	SSB	0500	Fixed		
	AM	02	Fixed		
	FM	05	01	—	02

Table 6-6

* IF passband width is fixed even though the IC-R9000 accepts IF passband width data for wide-FM mode.

CI-V COMPUTER INTERFACE CODES

4/25/89

Additional codes for IC-R9000

Command	description	data length
11 00	Att. off	1
11 10	Att. 10db	1
11 xx	Att. xxdb	vary
14 01	AF gain set	2-3
14 02	RF gain set	2-3
14 03	SQL level set	2-3
15 01	Read SQL on/off	0
15 02	Read SIG level	0

Note:

AF gain, RF gain, SQL level setting

Data range is 00(min.) to 255(max.).

In case of R9000, resolution is 32 levels.

Data	Gain
0 - 7	0
8 - 15	1
16 - 23	2
~ ~	~
248 - 255	31

Default code
2AH (Hex) dec = 42

7-1 Transceive commands

Command 00H Transfers operating frequency data. No response from any radio.

Radio ↔ radio

This command is used to transfer operating frequency data automatically among several radios. (Section 2-9)

When the operating frequency is changed on a radio, the radio automatically transfers the operating frequency data to other radios. No manual operation is required.

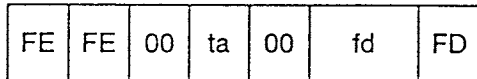

00

Receive address

When the operating frequency is changed on a radio, the radio automatically selects the receive address, 00H.

ta

Transmit address

The radio automatically specifies its address.

00

Command number

The radio automatically specifies the command number, 00H.

fd

Operating frequency data

The radio automatically transmits its operating frequency data in BCD code. (Section 1-10)

[Example] When operating frequency data is 145.123450 MHz.

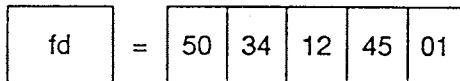

NOTE: If the transceive function is OFF, the radio does not transfer or receive the operating frequency data from other radios. (Section 2-10)

Each radio that is connected on the same CI-V bus line receives the operating frequency data. As long as the received frequency data is within its operating frequency range, each radio accepts the data and changes the displayed operating frequency.

Unlike command 05H, no radio transmits an OK or NG code even when this command is received.

Controller → radio

This command also can be used to transfer operating frequency data from the controller to several radios simultaneously or only to a specified radio.

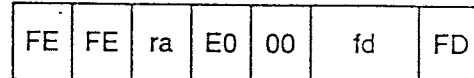

ra

Receive address

Specify the receive address as below:

00H for radios with the transceive function is ON. (Section 2-10)

A radio address only for a specified radio. (Section 2-5)

E0

Transmit address

Specify the controller's address, E0H.

00

Command number

Specify the command number, 00H.

fd

Operating frequency data

Specify operating frequency data in BCD code as in the example at left. (Sections 1-10, 5-2)

NOTE: Each radio that is connected on the same CI-V bus line receives the operating frequency data as below:

When the receive address 00H is specified, radios with the transceive function ON receive the data.

When the receive address is not 00H, only the specified radio receives the data.

If the transceive function is OFF, the radio does not receive command 00H with the receive address 00H, and receives only a command with the radio's address.

Unlike command 05H, no radio transmits an OK or NG code even when this command is received.

Command 01H Transfers operating mode data. No response from any radio.

Radio ↔ radio

This command is used to transfer operating mode data automatically among several radios. (Section 2-9)

When the operating mode is changed on a radio, the radio automatically transfers the operating mode data to other radios. No manual operation is required.

FE	FE	00	ta	01	md	pd	FD
----	----	----	----	----	----	----	----

- 00** **Receive address**
When the operating mode is changed on a radio, the radio automatically specifies the receive address, 00H.
- ta** **Transmit address**
The radio automatically specifies its address.
- 01** **Command number**
The radio automatically specifies the command number, 01H.
- md** **Operating mode data**
The radio automatically transmits its operating mode data in BCD code. (Sections 1-10, 6-6)
- pd** **IF passband width data**
If the radio is equipped with IF passband width selection capability via the CI-V System, when IF passband width is changed, the radio transmits the data in BCD code. (Sections 1-10, 6-6)

NOTE: If the function is OFF, the radio does not transfer or receive the operating mode data with other radios. (Section 2-10)

Each radio that is connected on the same CI-V bus line receives the operating mode and IF passband width data.

Unlike command 06H, no radio transmits an OK or NG code even when this command is received.

Controller → radio

This command also can be used to transfer operating frequency data from the controller to several radios simultaneously or only to a specified radio.

FE	FE	ra	E0	01	md	pd	FD
----	----	----	----	----	----	----	----

- ra** **Receive address**
Specify receive address as below:
00H for radios with the transceive function is ON. (Section 2-10)
A radio address for only a specified radio. (Section 2-5)
- E0** **Transmit address**
Specify the controller's address, E0H.
- 01** **Command number**
Specify the command number, 01H.
- md** **Operating mode data**
Specify operating mode data. (Section 6-6)
- pd** **IF passband width data**
If the radio is equipped with IF passband width selection capability via the CI-V System, this data can be specified. (Section 6-6)

NOTE: Each radio that is connected on the same CI-V bus line receives the operating mode and IF passband width data as below:

- When the receive address 00H is specified, radios with the transceive function ON receive the data.
- When the receive address is not 00H, only the specified radio receives the data.

If the transceive function is OFF, the radio does not receive command 01H with the receive address 00H and receives only a command with the radio's address.

Unlike command 06H, no radio transmits an OK or NG code even when this command is received.

7-2 Upper/lower-edge frequency readout command

Command **02H** Reads out upper/lower-edge frequency data.

■ Controller → radio

FE	FE	ra	E0	02	FD
----	----	----	----	----	----

ra **Receive address**
Specify a radio's address. (Section 2-5)

E0 **Transmit address**
Specify the controller's address, E0H.

02 **Command number**
Specify the command number, 02H.

■ Radio → controller

FE	FE	E0	ra	02	le	2D	he	FD
----	----	----	----	----	----	----	----	----

E0 **Receive address**
The radio automatically specifies the controller's address, E0H.

ra **Transmit address**
The radio automatically specifies its address.

02 **Command number**
The radio automatically specifies the received command number, 02H.

le **Lower-edge frequency data**
The radio sends back lower-edge frequency data in BCD code. (Sections 1-10, 5-2)

2D **Separator code**
To punctuate the space between the lower-edge and higher-edge frequency data, the radio sends back a separator, 2DH.

he **Higher-edge frequency data**
The radio sends back higher-edge frequency data in BCD code. (Sections 1-10, 5-2)

[Example] When the lower-edge frequency is 144.000000 MHz and higher-edge frequency is 146.000000 MHz.

le	=	00	00	00	44	01
----	---	----	----	----	----	----

he	=	00	00	00	46	01
----	---	----	----	----	----	----

NOTE: Depending on the radio's condition, the arrangement of lower and higher-edge frequency data may be reversed.

If the radio is equipped with scan edge channels P1 and P2, the radio transmits these channel contents. If the radio is not equipped with scan edge channels, the radio transmits its highest and lowest band edge frequencies.

7-3 Operating frequency, mode readout commands

Command 03H	Reads out operating frequency data.													
■ Controller → radio	■ Radio → controller													
<table border="1" style="display: inline-table; border-collapse: collapse;"> <tr> <td style="padding: 2px 5px;">FE</td> <td style="padding: 2px 5px;">FE</td> <td style="padding: 2px 5px;">ra</td> <td style="padding: 2px 5px;">E0</td> <td style="padding: 2px 5px;">03</td> <td style="padding: 2px 5px;">FD</td> </tr> </table>	FE	FE	ra	E0	03	FD	<table border="1" style="display: inline-table; border-collapse: collapse;"> <tr> <td style="padding: 2px 5px;">FE</td> <td style="padding: 2px 5px;">FE</td> <td style="padding: 2px 5px;">E0</td> <td style="padding: 2px 5px;">ra</td> <td style="padding: 2px 5px;">03</td> <td style="padding: 2px 5px;">fd</td> <td style="padding: 2px 5px;">FD</td> </tr> </table>	FE	FE	E0	ra	03	fd	FD
FE	FE	ra	E0	03	FD									
FE	FE	E0	ra	03	fd	FD								
<table border="1" style="display: inline-table; border-collapse: collapse;"> <tr> <td style="padding: 2px 5px;">ra</td> <td style="padding: 5px;">Receive address Specify a radio's address. (Section 2-5)</td> </tr> </table>	ra	Receive address Specify a radio's address. (Section 2-5)	<table border="1" style="display: inline-table; border-collapse: collapse;"> <tr> <td style="padding: 2px 5px;">E0</td> <td style="padding: 5px;">Receive address The radio automatically specifies the controller's address, E0H.</td> </tr> </table>	E0	Receive address The radio automatically specifies the controller's address, E0H.									
ra	Receive address Specify a radio's address. (Section 2-5)													
E0	Receive address The radio automatically specifies the controller's address, E0H.													
<table border="1" style="display: inline-table; border-collapse: collapse;"> <tr> <td style="padding: 2px 5px;">E0</td> <td style="padding: 5px;">Transmit address Specify the controller's address, E0H.</td> </tr> </table>	E0	Transmit address Specify the controller's address, E0H.	<table border="1" style="display: inline-table; border-collapse: collapse;"> <tr> <td style="padding: 2px 5px;">ra</td> <td style="padding: 5px;">Transmit address The radio automatically specifies its address.</td> </tr> </table>	ra	Transmit address The radio automatically specifies its address.									
E0	Transmit address Specify the controller's address, E0H.													
ra	Transmit address The radio automatically specifies its address.													
<table border="1" style="display: inline-table; border-collapse: collapse;"> <tr> <td style="padding: 2px 5px;">03</td> <td style="padding: 5px;">Command number Specify the command number, 03H.</td> </tr> </table>	03	Command number Specify the command number, 03H.	<table border="1" style="display: inline-table; border-collapse: collapse;"> <tr> <td style="padding: 2px 5px;">03</td> <td style="padding: 5px;">Command number The radio automatically specifies the received command number, 03H.</td> </tr> </table>	03	Command number The radio automatically specifies the received command number, 03H.									
03	Command number Specify the command number, 03H.													
03	Command number The radio automatically specifies the received command number, 03H.													
<p>NOTE: If a blank channel is selected, the radio sends back the memory blank code, FFH, except for the IC-761 and CI-IV radios. (Section 5-3)</p>														
<table border="1" style="display: inline-table; border-collapse: collapse;"> <tr> <td style="padding: 2px 5px;">fd</td> <td style="padding: 5px;">Operating frequency data The radio sends back operating frequency data in BCD code. (Sections 1-10, 5-2)</td> </tr> </table>	fd	Operating frequency data The radio sends back operating frequency data in BCD code. (Sections 1-10, 5-2)												
fd	Operating frequency data The radio sends back operating frequency data in BCD code. (Sections 1-10, 5-2)													

Command 04H	Reads out the operating mode and IF passband width data.														
■ Controller → radio	■ Radio → controller														
<table border="1" style="display: inline-table; border-collapse: collapse;"> <tr> <td style="padding: 2px 5px;">FE</td> <td style="padding: 2px 5px;">FE</td> <td style="padding: 2px 5px;">ra</td> <td style="padding: 2px 5px;">E0</td> <td style="padding: 2px 5px;">04</td> <td style="padding: 2px 5px;">FD</td> </tr> </table>	FE	FE	ra	E0	04	FD	<table border="1" style="display: inline-table; border-collapse: collapse;"> <tr> <td style="padding: 2px 5px;">FE</td> <td style="padding: 2px 5px;">FE</td> <td style="padding: 2px 5px;">E0</td> <td style="padding: 2px 5px;">ra</td> <td style="padding: 2px 5px;">04</td> <td style="padding: 2px 5px;">md</td> <td style="padding: 2px 5px;">pd</td> <td style="padding: 2px 5px;">FD</td> </tr> </table>	FE	FE	E0	ra	04	md	pd	FD
FE	FE	ra	E0	04	FD										
FE	FE	E0	ra	04	md	pd	FD								
<table border="1" style="display: inline-table; border-collapse: collapse;"> <tr> <td style="padding: 2px 5px;">ra</td> <td style="padding: 5px;">Receive address Specify a radio's address. (Section 2-5)</td> </tr> </table>	ra	Receive address Specify a radio's address. (Section 2-5)	<table border="1" style="display: inline-table; border-collapse: collapse;"> <tr> <td style="padding: 2px 5px;">E0</td> <td style="padding: 5px;">Receive address The radio automatically specifies the controller's address, E0H.</td> </tr> </table>	E0	Receive address The radio automatically specifies the controller's address, E0H.										
ra	Receive address Specify a radio's address. (Section 2-5)														
E0	Receive address The radio automatically specifies the controller's address, E0H.														
<table border="1" style="display: inline-table; border-collapse: collapse;"> <tr> <td style="padding: 2px 5px;">E0</td> <td style="padding: 5px;">Transmit address Specify the controller's address, E0H.</td> </tr> </table>	E0	Transmit address Specify the controller's address, E0H.	<table border="1" style="display: inline-table; border-collapse: collapse;"> <tr> <td style="padding: 2px 5px;">ra</td> <td style="padding: 5px;">Transmit address The radio automatically specifies its address.</td> </tr> </table>	ra	Transmit address The radio automatically specifies its address.										
E0	Transmit address Specify the controller's address, E0H.														
ra	Transmit address The radio automatically specifies its address.														
<table border="1" style="display: inline-table; border-collapse: collapse;"> <tr> <td style="padding: 2px 5px;">04</td> <td style="padding: 5px;">Command number Specify the command number, 04H.</td> </tr> </table>	04	Command number Specify the command number, 04H.	<table border="1" style="display: inline-table; border-collapse: collapse;"> <tr> <td style="padding: 2px 5px;">04</td> <td style="padding: 5px;">Command number The radio automatically specifies the received command number, 04H.</td> </tr> </table>	04	Command number The radio automatically specifies the received command number, 04H.										
04	Command number Specify the command number, 04H.														
04	Command number The radio automatically specifies the received command number, 04H.														
<p>NOTE: If a blank channel is selected, the radio sends back the memory blank code, FFH, except for the IC-761 and CI-IV radios. (Section 5-3)</p>															
<table border="1" style="display: inline-table; border-collapse: collapse;"> <tr> <td style="padding: 2px 5px;">md</td> <td style="padding: 5px;">Operating mode data The radio sends back operating mode data.</td> </tr> </table>	md	Operating mode data The radio sends back operating mode data.													
md	Operating mode data The radio sends back operating mode data.														
<table border="1" style="display: inline-table; border-collapse: collapse;"> <tr> <td style="padding: 2px 5px;">pd</td> <td style="padding: 5px;">IF passband width data The radio may send back IF passband width data. (Section 6-6)</td> </tr> </table>	pd	IF passband width data The radio may send back IF passband width data. (Section 6-6)													
pd	IF passband width data The radio may send back IF passband width data. (Section 6-6)														

7-4 Operating frequency, mode writing commands

Command 05H	Writes operating frequency data into a displayed VFO or memory channel.													
■ Controller → radio	■ Radio → controller													
<table border="1" style="display: inline-table; border-collapse: collapse;"> <tr> <td style="padding: 2px 5px;">FE</td> <td style="padding: 2px 5px;">FE</td> <td style="padding: 2px 5px;">ra</td> <td style="padding: 2px 5px;">E0</td> <td style="padding: 2px 5px;">05</td> <td style="padding: 2px 5px;">fd</td> <td style="padding: 2px 5px;">FD</td> </tr> </table>	FE	FE	ra	E0	05	fd	FD	<table border="1" style="display: inline-table; border-collapse: collapse;"> <tr> <td style="padding: 2px 5px;">FE</td> <td style="padding: 2px 5px;">FE</td> <td style="padding: 2px 5px;">E0</td> <td style="padding: 2px 5px;">ra</td> <td style="padding: 2px 5px;">FB or FA</td> <td style="padding: 2px 5px;">FD</td> </tr> </table>	FE	FE	E0	ra	FB or FA	FD
FE	FE	ra	E0	05	fd	FD								
FE	FE	E0	ra	FB or FA	FD									
<table border="1" style="display: inline-table; border-collapse: collapse;"> <tr> <td style="padding: 2px 5px;">ra</td> <td style="padding: 5px;">Receive address</td> </tr> </table> <p style="margin-left: 20px;">Specify a radio's address. (Section 2-5)</p>	ra	Receive address	<table border="1" style="display: inline-table; border-collapse: collapse;"> <tr> <td style="padding: 2px 5px;">FB</td> <td style="padding: 5px;">OK code</td> </tr> </table> <p style="margin-left: 20px;">When the correct command is received, the radio operates as follows.</p> <p style="margin-left: 40px;">Selects the specified operating frequency for the displayed VFO or memory channel.</p> <p style="margin-left: 40px;">Sends back the OK code, FBH.</p>	FB	OK code									
ra	Receive address													
FB	OK code													
<table border="1" style="display: inline-table; border-collapse: collapse;"> <tr> <td style="padding: 2px 5px;">E0</td> <td style="padding: 5px;">Transmit address</td> </tr> </table> <p style="margin-left: 20px;">Specify the controller's address, E0H.</p>	E0	Transmit address	<table border="1" style="display: inline-table; border-collapse: collapse;"> <tr> <td style="padding: 2px 5px;">FA</td> <td style="padding: 5px;">NG code</td> </tr> </table> <p style="margin-left: 20px;">If the specified frequency range does not correspond to the radio's operating frequency range, the radio sends back the NG code, FAH.</p>	FA	NG code									
E0	Transmit address													
FA	NG code													
<table border="1" style="display: inline-table; border-collapse: collapse;"> <tr> <td style="padding: 2px 5px;">05</td> <td style="padding: 5px;">Command number</td> </tr> </table> <p style="margin-left: 20px;">Specify the command number, 05H.</p>	05	Command number												
05	Command number													
<table border="1" style="display: inline-table; border-collapse: collapse;"> <tr> <td style="padding: 2px 5px;">fd</td> <td style="padding: 5px;">Operating frequency data</td> </tr> </table> <p style="margin-left: 20px;">Specify operating frequency data in BCD code. (Section 1-10)</p> <p>[Example] When the specified operating frequency data is 145.123450 MHz.</p>	fd	Operating frequency data												
fd	Operating frequency data													
<table border="1" style="display: inline-table; border-collapse: collapse;"> <tr> <td style="padding: 2px 5px;">fd</td> <td style="padding: 5px;">=</td> <td style="padding: 2px 5px;">50</td> <td style="padding: 2px 5px;">34</td> <td style="padding: 2px 5px;">12</td> <td style="padding: 2px 5px;">45</td> <td style="padding: 2px 5px;">01</td> </tr> </table>	fd	=	50	34	12	45	01							
fd	=	50	34	12	45	01								

Command 06H	Writes operating mode data into a displayed VFO or memory channel.														
■ Controller → radio	■ Radio → controller														
<table border="1" style="display: inline-table; border-collapse: collapse;"> <tr> <td style="padding: 2px 5px;">FE</td> <td style="padding: 2px 5px;">FE</td> <td style="padding: 2px 5px;">ra</td> <td style="padding: 2px 5px;">E0</td> <td style="padding: 2px 5px;">06</td> <td style="padding: 2px 5px;">md</td> <td style="padding: 2px 5px;">pd</td> <td style="padding: 2px 5px;">FD</td> </tr> </table>	FE	FE	ra	E0	06	md	pd	FD	<table border="1" style="display: inline-table; border-collapse: collapse;"> <tr> <td style="padding: 2px 5px;">FE</td> <td style="padding: 2px 5px;">FE</td> <td style="padding: 2px 5px;">E0</td> <td style="padding: 2px 5px;">ra</td> <td style="padding: 2px 5px;">FB or FA</td> <td style="padding: 2px 5px;">FD</td> </tr> </table>	FE	FE	E0	ra	FB or FA	FD
FE	FE	ra	E0	06	md	pd	FD								
FE	FE	E0	ra	FB or FA	FD										
<table border="1" style="display: inline-table; border-collapse: collapse;"> <tr> <td style="padding: 2px 5px;">ra</td> <td style="padding: 5px;">Receive address</td> </tr> </table> <p style="margin-left: 20px;">Specify a radio's address. (Section 2-5)</p>	ra	Receive address	<table border="1" style="display: inline-table; border-collapse: collapse;"> <tr> <td style="padding: 2px 5px;">FB</td> <td style="padding: 5px;">OK code</td> </tr> </table> <p style="margin-left: 20px;">When the correct command is received, the radio operates as follows.</p> <p style="margin-left: 40px;">Selects the specified operating mode for the displayed VFO or memory channel.</p> <p style="margin-left: 40px;">Sends back the OK code, FBH.</p>	FB	OK code										
ra	Receive address														
FB	OK code														
<table border="1" style="display: inline-table; border-collapse: collapse;"> <tr> <td style="padding: 2px 5px;">E0</td> <td style="padding: 5px;">Transmit address</td> </tr> </table> <p style="margin-left: 20px;">Specify the controller's address, E0H.</p>	E0	Transmit address	<table border="1" style="display: inline-table; border-collapse: collapse;"> <tr> <td style="padding: 2px 5px;">FA</td> <td style="padding: 5px;">NG code</td> </tr> </table> <p style="margin-left: 20px;">Under the following conditions, the radio sends back the NG code, FAH.</p> <p style="margin-left: 40px;">The transceiver is not equipped with the specified mode.</p> <p style="margin-left: 40px;">The radio is not equipped with IF passband width selection capability with the CI-V System.</p>	FA	NG code										
E0	Transmit address														
FA	NG code														
<table border="1" style="display: inline-table; border-collapse: collapse;"> <tr> <td style="padding: 2px 5px;">06</td> <td style="padding: 5px;">Command number</td> </tr> </table> <p style="margin-left: 20px;">Specify the command number, 06H.</p>	06	Command number													
06	Command number														
<table border="1" style="display: inline-table; border-collapse: collapse;"> <tr> <td style="padding: 2px 5px;">md</td> <td style="padding: 5px;">Operating mode data</td> </tr> </table> <p style="margin-left: 20px;">Specify operating mode data in BCD code. (Section 6-6)</p>	md	Operating mode data													
md	Operating mode data														
<table border="1" style="display: inline-table; border-collapse: collapse;"> <tr> <td style="padding: 2px 5px;">pd</td> <td style="padding: 5px;">IF passband width data</td> </tr> </table> <p style="margin-left: 20px;">If the radio is equipped with IF passband width selection capability with the CI-V System, the information can be specified. (Section 6-6)</p>	pd	IF passband width data													
pd	IF passband width data														

7-5 VFO selection command

Command 07H	Sub commands 00H~D1H	Selects VFO mode. Selects VFO A or VFO B. [VFO]																				
■ Controller → radio		■ Radio → controller																				
<table border="1" style="width: 100%; text-align: center; border-collapse: collapse;"> <tr> <td style="width: 12.5%;">FE</td> <td style="width: 12.5%;">FE</td> <td style="width: 12.5%;">ra</td> <td style="width: 12.5%;">E0</td> <td style="width: 12.5%;">07</td> <td style="width: 12.5%;">sc</td> <td style="width: 12.5%;">FD</td> </tr> </table>		FE	FE	ra	E0	07	sc	FD	<table border="1" style="width: 100%; text-align: center; border-collapse: collapse;"> <tr> <td style="width: 12.5%;">FE</td> <td style="width: 12.5%;">FE</td> <td style="width: 12.5%;">E0</td> <td style="width: 12.5%;">ra</td> <td style="width: 12.5%;">FB or FA</td> <td style="width: 12.5%;">FD</td> </tr> </table>	FE	FE	E0	ra	FB or FA	FD							
FE	FE	ra	E0	07	sc	FD																
FE	FE	E0	ra	FB or FA	FD																	
<table border="1" style="width: 100%; border-collapse: collapse;"> <tr> <td style="width: 10%; text-align: center;">ra</td> <td> Receive address Specify a radio's address. (Section 2-5) </td> </tr> <tr> <td style="text-align: center;">E0</td> <td> Transmit address Specify the controller's address, E0H. </td> </tr> <tr> <td style="text-align: center;">07</td> <td> Command number Specify the command number, 07H. </td> </tr> <tr> <td style="text-align: center;">sc</td> <td> Sub command number Specify the sub command number. </td> </tr> </table>	ra	Receive address Specify a radio's address. (Section 2-5)	E0	Transmit address Specify the controller's address, E0H.	07	Command number Specify the command number, 07H.	sc	Sub command number Specify the sub command number.	<table border="1" style="width: 100%; border-collapse: collapse;"> <tr> <td style="width: 10%; text-align: center;">FB</td> <td> OK code When the correct command is received, the radio operates as follows. Selects the specified operation described at left below. Sends back the OK code, FBH. </td> </tr> <tr> <td style="text-align: center;">FA</td> <td> NG code Under the following conditions, the radio sends back the NG code, FAH. The radio is not equipped with the specified function. The radio is not equipped with a VFO. </td> </tr> </table>	FB	OK code When the correct command is received, the radio operates as follows. Selects the specified operation described at left below. Sends back the OK code, FBH.	FA	NG code Under the following conditions, the radio sends back the NG code, FAH. The radio is not equipped with the specified function. The radio is not equipped with a VFO.									
ra	Receive address Specify a radio's address. (Section 2-5)																					
E0	Transmit address Specify the controller's address, E0H.																					
07	Command number Specify the command number, 07H.																					
sc	Sub command number Specify the sub command number.																					
FB	OK code When the correct command is received, the radio operates as follows. Selects the specified operation described at left below. Sends back the OK code, FBH.																					
FA	NG code Under the following conditions, the radio sends back the NG code, FAH. The radio is not equipped with the specified function. The radio is not equipped with a VFO.																					
<table border="1" style="width: 100%; border-collapse: collapse;"> <thead> <tr> <th style="width: 10%; text-align: center;">sc</th> <th style="text-align: center;">Operation</th> </tr> </thead> <tbody> <tr> <td style="text-align: center;">—</td> <td>When no sub command is added, the radio changes from MEMORY mode to the previously used VFO.</td> </tr> <tr> <td style="text-align: center;">00</td> <td>Changes from MEMORY mode to VFO A, or from VFO B to VFO A.</td> </tr> <tr> <td style="text-align: center;">01</td> <td>Changes from MEMORY mode to VFO B, or from VFO A to VFO B.</td> </tr> <tr> <td style="text-align: center;">A0</td> <td>Copies displayed VFO contents to another VFO. [VFO A = VFO B]</td> </tr> <tr> <td style="text-align: center;">B0</td> <td>Exchanges VFO A contents with VFO B contents. [VFO A ↔ VFO B] For the IC-970A/E/H, exchanges MAIN band and SUB band. [MAIN ↔ SUB]</td> </tr> <tr> <td style="text-align: center;">C0</td> <td>Turns the dual watch function OFF.</td> </tr> <tr> <td style="text-align: center;">C1</td> <td>Turns the dual watch function ON.</td> </tr> <tr> <td style="text-align: center;">D0</td> <td>Accesses MAIN band.</td> </tr> <tr> <td style="text-align: center;">D1</td> <td>Accesses SUB band.</td> </tr> </tbody> </table>		sc	Operation	—	When no sub command is added, the radio changes from MEMORY mode to the previously used VFO.	00	Changes from MEMORY mode to VFO A, or from VFO B to VFO A.	01	Changes from MEMORY mode to VFO B, or from VFO A to VFO B.	A0	Copies displayed VFO contents to another VFO. [VFO A = VFO B]	B0	Exchanges VFO A contents with VFO B contents. [VFO A ↔ VFO B] For the IC-970A/E/H, exchanges MAIN band and SUB band. [MAIN ↔ SUB]	C0	Turns the dual watch function OFF.	C1	Turns the dual watch function ON.	D0	Accesses MAIN band.	D1	Accesses SUB band.	
sc	Operation																					
—	When no sub command is added, the radio changes from MEMORY mode to the previously used VFO.																					
00	Changes from MEMORY mode to VFO A, or from VFO B to VFO A.																					
01	Changes from MEMORY mode to VFO B, or from VFO A to VFO B.																					
A0	Copies displayed VFO contents to another VFO. [VFO A = VFO B]																					
B0	Exchanges VFO A contents with VFO B contents. [VFO A ↔ VFO B] For the IC-970A/E/H, exchanges MAIN band and SUB band. [MAIN ↔ SUB]																					
C0	Turns the dual watch function OFF.																					
C1	Turns the dual watch function ON.																					
D0	Accesses MAIN band.																					
D1	Accesses SUB band.																					

7-6 Front window selection command

Command 07H	Sub command E0H	Selects the front window. [WINDOW]														
■ Controller → radio		■ Radio → controller														
<table border="1"> <tr> <td>FE</td> <td>FE</td> <td>ra</td> <td>E0</td> <td>07</td> <td>E0</td> <td>wn</td> <td>FD</td> </tr> </table>		FE	FE	ra	E0	07	E0	wn	FD	<table border="1"> <tr> <td>FE</td> <td>FE</td> <td>E0</td> <td>ra</td> <td>FB or FA</td> <td>FD</td> </tr> </table>	FE	FE	E0	ra	FB or FA	FD
FE	FE	ra	E0	07	E0	wn	FD									
FE	FE	E0	ra	FB or FA	FD											
<table border="1"> <tr> <td>ra</td> </tr> </table>	ra	Receive address Specify a radio's address. (Section 2-5)	<table border="1"> <tr> <td>FB</td> </tr> </table>	FB	OK code When the correct command is received, the radio operates as follows. Selects the specified window as the front window. Sends back the OK code, FBH.											
ra																
FB																
<table border="1"> <tr> <td>E0</td> </tr> </table>	E0	Transmit address Specify the controller's address, E0H.	<table border="1"> <tr> <td>FA</td> </tr> </table>	FA	NG code When the radio is not equipped with the window scan function, the radio sends back NG code, FAH.											
E0																
FA																
<table border="1"> <tr> <td>07</td> </tr> </table>	07	Command number Specify the command number, 07H.														
07																
<table border="1"> <tr> <td>E0</td> </tr> </table>	E0	Sub command number Specify the sub command number, E0H.														
E0																
<table border="1"> <tr> <td>wn</td> </tr> </table>	wn	Window number Specify a window number to select for the front window in BCD code. Either 00 or 01 can be specified.														
wn																
<p>NOTE: Window number 00 or 01 is used in the IC-R7100, even though the radio does not indicate it on the function display.</p> <p>There is no command to readout which window is the front window.</p>																

7-7 Memory channel commands

Command **08H** Selects MEMORY mode or specifies a memory channel number. [MR]

■ Controller → radio

FE	FE	ra	E0	08	mc	FD
----	----	----	----	----	----	----

ra **Receive address**
Specify a radio's address. (Section 2-5)

E0 **Transmit address**
Specify the controller's address, E0H.

08 **Command number**
Specify the command number, 08H.

mc **Memory channel number**
Specify the memory channel number in BCD code.

mc	Operation
—	When no memory channel number is specified, the radio selects the previously used memory channel.
00~99	Selects specified memory channel 0~99.
0100~9999	Selects specified memory channel 100~9999. A call channel or scan edge channel can be specified. (Sections 6-1-6-5)

[Example] Selects memory channel 15.

mc = **15**

[Example] Selects memory channel 102.

mc = **01 02**

■ Radio → controller

FE	FE	E0	ra	FB or FA	FD
----	----	----	----	----------	----

FB **OK code**
When the correct command is received, the radio operates as follows.
Selects the previously used or specified memory channel.
Sends back the OK code, FBH.

FA **NG code**
If the radio is not equipped with the specified memory channel, the radio sends back the NG code, FAH.

Command 09H	Writes displayed contents into a selected memory channel. [MW]												
<p>■ Controller → radio</p> <table border="1" style="width: 100%; text-align: center; border-collapse: collapse;"> <tr> <td style="width: 12.5%;">FE</td> <td style="width: 12.5%;">FE</td> <td style="width: 12.5%;">ra</td> <td style="width: 12.5%;">E0</td> <td style="width: 12.5%;">09</td> <td style="width: 12.5%;">FD</td> </tr> </table> <p>ra Receive address Specify a radio's address. (Section 2-5)</p> <p>E0 Transmit address Specify the controller's address, E0H.</p> <p>09 Command number Specify the command number, 09H.</p>	FE	FE	ra	E0	09	FD	<p>■ Radio → controller</p> <table border="1" style="width: 100%; text-align: center; border-collapse: collapse;"> <tr> <td style="width: 12.5%;">FE</td> <td style="width: 12.5%;">FE</td> <td style="width: 12.5%;">E0</td> <td style="width: 12.5%;">ra</td> <td style="width: 12.5%;">FB or FA</td> <td style="width: 12.5%;">FD</td> </tr> </table> <p>FB OK code When the correct command is received, the radio operates as follows. Writes displayed contents including the operating frequency, mode, etc. into the previously selected memory channel. Sends back the OK code, FBH.</p> <p>FA NG code If the radio is not equipped with any memory channel, the radio sends back the NG code, FAH.</p>	FE	FE	E0	ra	FB or FA	FD
FE	FE	ra	E0	09	FD								
FE	FE	E0	ra	FB or FA	FD								

Command 0AH	Copies selected memory channel contents into a VFO. [M→VFO]												
<p>■ Controller → radio</p> <table border="1" style="width: 100%; text-align: center; border-collapse: collapse;"> <tr> <td style="width: 12.5%;">FE</td> <td style="width: 12.5%;">FE</td> <td style="width: 12.5%;">ra</td> <td style="width: 12.5%;">E0</td> <td style="width: 12.5%;">0A</td> <td style="width: 12.5%;">FD</td> </tr> </table> <p>ra Receive address Specify a radio's address. (Section 2-5)</p> <p>E0 Transmit address Specify the controller's address, E0H.</p> <p>0A Command number Specify the command number, 0AH.</p>	FE	FE	ra	E0	0A	FD	<p>■ Radio → controller</p> <table border="1" style="width: 100%; text-align: center; border-collapse: collapse;"> <tr> <td style="width: 12.5%;">FE</td> <td style="width: 12.5%;">FE</td> <td style="width: 12.5%;">E0</td> <td style="width: 12.5%;">ra</td> <td style="width: 12.5%;">FB or FA</td> <td style="width: 12.5%;">FD</td> </tr> </table> <p>FB OK code When the correct command is received, the radio operates as follows. Copies displayed memory channel contents including the operating frequency, mode, etc. into the previously used VFO. Sends back the OK code, FBH.</p> <p>FA NG code If a blank channel is selected, the radio sends back the NG code, FAH.</p> <p>NOTE: The displayed memory channels content are not affected.</p>	FE	FE	E0	ra	FB or FA	FD
FE	FE	ra	E0	0A	FD								
FE	FE	E0	ra	FB or FA	FD								

Command **0BH** Clears selected memory channel contents. [M CLEAR]

■ Controller → radio

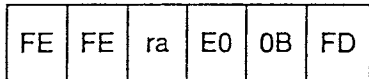

ra **Receive address**
Specify a radio's address. (Section 2-5)

E0 **Transmit address**
Specify the controller's address, E0H.

0B **Command number**
Specify the command number, 0BH.

■ Radio → controller

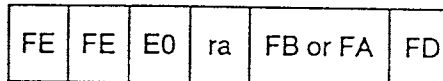

FB **OK code**
When the correct command is received, the radio operates as follows.

Writes the memory blank code, FFH, into the selected memory channel.

Sends back the OK code, FBH.

FA **NG code**
If the radio is not equipped with any memory channel, the radio sends back the NG code, FAH.

NOTE: The IC-761 or a radio that is equipped with the CI-IV System preserves previous memory contents even though contents of blank channels are not displayed.

7-8 Offset frequency commands

Command 0CH Reads out offset frequency contents in a displayed VFO or memory channel.

Controller → radio

FE	FE	ra	E0	0C	FD
----	----	----	----	----	----

- ra** **Receive address**
Specify a radio's address. (Section 2-5)
- E0** **Transmit address**
Specify the controller's address, E0H.
- 0C** **Command number**
Specify the command number, 0CH.

Radio → controller

FE	FE	E0	ra	0C	od	FD
----	----	----	----	----	----	----

- od** **Offset frequency data**
When the correct command is received, the radio sends back offset frequency data in BCD code.

[Example] When offset frequency is 20 MHz.

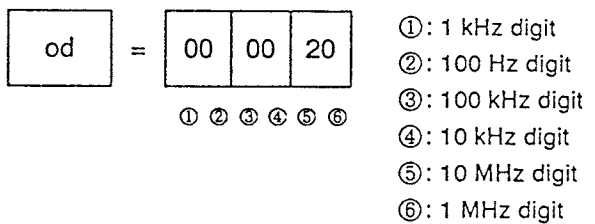

NOTE: If the offset frequency is not included, the radio sends back 000000. If a blank channel is selected, the radio sends back the NG code, FAH. (Section 5-3)

Command 0DH Writes offset frequency data into a displayed VFO or memory channel.

Controller → radio

FE	FE	ra	E0	0D	od	FD
----	----	----	----	----	----	----

- ra** **Receive address**
Specify a radio's address. (Section 2-5)
- E0** **Transmit address**
Specify the controller's address, E0H.
- 0D** **Command number**
Specify the command number, 0DH.
- od** **Offset frequency data**
Specify offset frequency data in BCD code as in the example shown in command 0CH.

Radio → controller

FE	FE	E0	ra	FB or FA	FD
----	----	----	----	----------	----

- FB** **OK code**
When the correct command is received, the radio operates as follows.
Writes the specified offset frequency data into the displayed VFO or memory channel.
Sends back the OK code, FBH.
- FA** **NG code**
If the radio is not equipped with the offset function, the radio sends back the NG code, FAH.

7-9 Scan start/stop command

Command 0EH	Sub commands 00H~42H	Starts and stops a scan function.												
<p>Controller → radio</p> <p>These commands are used for scan start/stop controls.</p> <p>For scan controls on the front window in the IC-R7100, this command is used. For window scan controls, refer to Sections 7-12 and 7-13.</p>		<p>Radio → controller</p>												
<table border="1"> <tr> <td>FE</td><td>FE</td><td>ra</td><td>E0</td><td>0E</td><td>sc</td><td>FD</td> </tr> </table>	FE	FE	ra	E0	0E	sc	FD	<table border="1"> <tr> <td>FE</td><td>FE</td><td>E0</td><td>ra</td><td>FB or FA</td><td>FD</td> </tr> </table>	FE	FE	E0	ra	FB or FA	FD
FE	FE	ra	E0	0E	sc	FD								
FE	FE	E0	ra	FB or FA	FD									
<table border="1"> <tr> <td>ra</td> <td>Receive address Specify a radio's address. (Section 2-5)</td> </tr> </table>	ra	Receive address Specify a radio's address. (Section 2-5)	<table border="1"> <tr> <td>FB</td> <td>OK code When the correct command is received, the radio operates as follows. Performs the specified function. Sends back the OK code, FBH.</td> </tr> </table>	FB	OK code When the correct command is received, the radio operates as follows. Performs the specified function. Sends back the OK code, FBH.									
ra	Receive address Specify a radio's address. (Section 2-5)													
FB	OK code When the correct command is received, the radio operates as follows. Performs the specified function. Sends back the OK code, FBH.													
<table border="1"> <tr> <td>E0</td> <td>Transmit address Specify the controller's address, E0H.</td> </tr> </table>	E0	Transmit address Specify the controller's address, E0H.	<table border="1"> <tr> <td>FA</td> <td>NG code Under the following conditions, the radio sends back the NG code, FAH. When the specified function could not be performed. Selectable sub command differs according to VFO mode or MEMORY mode. The radio is not equipped with the specified scan function.</td> </tr> </table>	FA	NG code Under the following conditions, the radio sends back the NG code, FAH. When the specified function could not be performed. Selectable sub command differs according to VFO mode or MEMORY mode. The radio is not equipped with the specified scan function.									
E0	Transmit address Specify the controller's address, E0H.													
FA	NG code Under the following conditions, the radio sends back the NG code, FAH. When the specified function could not be performed. Selectable sub command differs according to VFO mode or MEMORY mode. The radio is not equipped with the specified scan function.													
<table border="1"> <tr> <td>0E</td> <td>Command number Specify the command number, 0EH.</td> </tr> </table>	0E	Command number Specify the command number, 0EH.												
0E	Command number Specify the command number, 0EH.													
<table border="1"> <tr> <td>sc</td> <td>Sub command number Specify the sub command number. (Section 7-11)</td> </tr> </table>	sc	Sub command number Specify the sub command number. (Section 7-11)												
sc	Sub command number Specify the sub command number. (Section 7-11)													
<p>[Example] Starts programmed scan or memory scan.</p>														
<table border="1"> <tr> <td>FE</td><td>FE</td><td>ra</td><td>E0</td><td>0E</td><td>01</td><td>FD</td> </tr> </table>		FE	FE	ra	E0	0E	01	FD						
FE	FE	ra	E0	0E	01	FD								
<p>[Example] Stops scan.</p>														
<table border="1"> <tr> <td>FE</td><td>FE</td><td>ra</td><td>E0</td><td>0E</td><td>00</td><td>FD</td> </tr> </table>		FE	FE	ra	E0	0E	00	FD						
FE	FE	ra	E0	0E	00	FD								
<p>[Example] Starts auto memory write scan.</p>														
<table border="1"> <tr> <td>FE</td><td>FE</td><td>ra</td><td>E0</td><td>0E</td><td>04</td><td>FD</td> </tr> </table>		FE	FE	ra	E0	0E	04	FD						
FE	FE	ra	E0	0E	04	FD								
<p>[Example] Starts selected number memory scan.</p>														
<table border="1"> <tr> <td>FE</td><td>FE</td><td>ra</td><td>E0</td><td>0E</td><td>23</td><td>FD</td> </tr> </table>		FE	FE	ra	E0	0E	23	FD						
FE	FE	ra	E0	0E	23	FD								
<p>[Example] Starts priority scan. (except for the IC-R7100)</p>														
<table border="1"> <tr> <td>FE</td><td>FE</td><td>ra</td><td>E0</td><td>0E</td><td>42</td><td>FD</td> </tr> </table>		FE	FE	ra	E0	0E	42	FD						
FE	FE	ra	E0	0E	42	FD								
<p>NOTE: Selectable sub command differs according to radios and operating conditions. (Sections 7-11)</p>														

7-10 Scan condition command

Command 0EH	Sub commands A0H~D3H	Specifies the scan conditions.																																												
<p>■ Controller → radio</p> <table border="1"> <tr> <td>FE</td><td>FE</td><td>ra</td><td>E0</td><td>0E</td><td>sc</td><td>sn</td><td>FD</td> </tr> </table> <p>ra Receive address Specify a radio's address. (Section 2-5)</p> <p>E0 Transmit address Specify the controller's address, E0H.</p> <p>0E Command number Specify the command number, 0EH.</p> <p>sc Sub command number Specify the sub command number. (Section 7-11)</p> <p>sn Selected number For sub command number B1H or B2H, this data can be specified in BCD code.</p> <p>[Example] Specifies the selected number as non effective for a displayed memory channel.</p> <table border="1"> <tr> <td>FE</td><td>FE</td><td>ra</td><td>E0</td><td>0E</td><td>B0</td><td>FD</td> </tr> </table> <p>[Example] Specifies the selected number 8 for the displayed memory channel.</p> <table border="1"> <tr> <td>FE</td><td>FE</td><td>ra</td><td>E0</td><td>0E</td><td>B1</td><td>08</td><td>FD</td> </tr> </table> <p>[Example] Specifies scan number 5 for the selected number memory scan.</p> <table border="1"> <tr> <td>FE</td><td>FE</td><td>ra</td><td>E0</td><td>0E</td><td>B2</td><td>05</td><td>FD</td> </tr> </table> <p>[Example] Turns the VSC function ON.</p> <table border="1"> <tr> <td>FE</td><td>FE</td><td>ra</td><td>E0</td><td>0E</td><td>C1</td><td>FD</td> </tr> </table>		FE	FE	ra	E0	0E	sc	sn	FD	FE	FE	ra	E0	0E	B0	FD	FE	FE	ra	E0	0E	B1	08	FD	FE	FE	ra	E0	0E	B2	05	FD	FE	FE	ra	E0	0E	C1	FD	<p>■ Radio → controller</p> <table border="1"> <tr> <td>FE</td><td>FE</td><td>E0</td><td>ra</td><td>FB or FA</td><td>FD</td> </tr> </table> <p>FB OK code When the correct command is received, the radio operates as follows. Performs the specified function. Sends back the OK code, FBH.</p> <p>FA NG code Under the following conditions, the radio sends back the NG code, FAH. When the specified function could not be performed. Selectable sub command differs according to VFO mode or MEMORY mode. The radio is not equipped with the specified scan function.</p>	FE	FE	E0	ra	FB or FA	FD
FE	FE	ra	E0	0E	sc	sn	FD																																							
FE	FE	ra	E0	0E	B0	FD																																								
FE	FE	ra	E0	0E	B1	08	FD																																							
FE	FE	ra	E0	0E	B2	05	FD																																							
FE	FE	ra	E0	0E	C1	FD																																								
FE	FE	E0	ra	FB or FA	FD																																									

7-11 Sub commands for command 0EH

Selectable sub commands for command 0EH

Radios	Selectable sub commands (sc)
IC-735, IC-751, IC-751A, IC-761, IC-271A/E/H, IC-471A/E/H, IC-1271A/E, IC-R71, IC-R7000	No scan function control capability via the CI-V System.
IC-725, IC-726 IC-737, IC-765, IC-575A/H, IC-275A/E/H, IC-375A, IC-475A/E/H, IC-1275A/E, IC-970A/E/H	00H, 01H
IC-781	00H-03H, 12H-23H, A0H-B2H
IC-R9000	00H, 02H-04H, 22H-42H, A0H-D3H
IC-R72	00H-02H, 04H, 22H, 23H, B0H, B1H
IC-R7100	00H, 02H, 04H, 22H-42H, B0H-D1H, D3H

Sub commands 00H~42H

sc	Operation
00	Scan stops.
01	Programmed scan or memory scan starts.
02	Programmed scan starts.
03	Δf scan starts.
04	Auto memory write scan starts.
12	Fine programmed scan starts.
13	Fine Δf scan starts.
22	Memory scan starts.
23	Selected number memory scan starts.
24	Selected mode memory scan starts.
42	Priority scan or basic window scan starts.

NOTE: For the IC-R7100, sub commands except 01H, 03H, 12H and 13H, described above are used.

For window scan controls, a window number **MUST** be added. (Sections 7-12, 7-13)

Sub commands A0H~D3H

sc	Operation
A0	Unfixes the center frequency for Δf scan.
AA	Fixes the center frequency for Δf scan.
A1	Selects Δf frequency width of ± 2.5 kHz.
A2	Selects Δf frequency width of ± 5 kHz.
A3	Selects Δf frequency width of ± 10 kHz.
A4	Selects Δf frequency width of ± 20 kHz.
A5	Selects Δf frequency width of ± 50 kHz.
B0	Selects the selected number non effective for a memory channel.
B1	Selects the selected number effective for a memory channel. For the IC-R9000, specifies the selected number for a memory channel.
B2	Specifies the scan number for a selected number memory scan.
C0	Turns VSC function OFF.
C1	Turns VSC function ON.
D0	Selects scan resume condition [∞].*
D1	Selects scan resume condition [OFF].*
D2	Selects scan resume condition [B].*
D3	Selects scan resume condition [A].*

*Refer to p. 46 of the IC-R9000 instruction manual or p. 22 of the IC-R7100 instruction manual.

7-12 Basic window scan command

Command 0EH	Sub command 42H	Starts a window scan function. [WS]														
<p>■ Controller → radio</p> <p>This command starts the IC-R7100's window scan. [WS]</p> <table border="1" style="width: 100%; text-align: center;"> <tr> <td>FE</td><td>FE</td><td>ra</td><td>E0</td><td>0E</td><td>42</td><td>wn</td><td>FD</td> </tr> </table> <p>ra Receive address Specify a radio's address. (Section 2-5)</p> <p>E0 Transmit address Specify the controller's address, E0H.</p> <p>0E Command number Specify the command number, 0EH.</p> <p>42 Sub command number Specify the sub command number, 42H.</p> <p>wn Window number Specify the back window number in BCD code. When no window number is specified, previously specified window number is used. Window number 00 or 01 is used in the IC-R7100, even though the radio does not indicate it on the function display. (Section 7-6)</p>		FE	FE	ra	E0	0E	42	wn	FD	<p>■ Radio → controller</p> <table border="1" style="width: 100%; text-align: center;"> <tr> <td>FE</td><td>FE</td><td>E0</td><td>ra</td><td>FB or FA</td><td>FD</td> </tr> </table> <p>FB OK code When the correct command is received, the radio operates as follows. Performs the specified function. Sends back the OK code, FBH.</p> <p>FA NG code Under the following conditions, the radio sends back the NG code, FAH. When the specified function could not be performed. When the front window is specified.</p>	FE	FE	E0	ra	FB or FA	FD
FE	FE	ra	E0	0E	42	wn	FD									
FE	FE	E0	ra	FB or FA	FD											

7-13 Advanced window scan start/stop command

Command 0EH	Sub commands 02H~24H	Starts a window scan function.														
<p>■ Controller → radio</p> <p>Advanced window scan start/stop command is special function for the IC-R7100.</p> <p>These commands start advanced window scan. In other words, basic window scan and basic scan start simultaneously.</p>		<p>■ Radio → controller</p>														
<table border="1"> <tr> <td>FE</td><td>FE</td><td>ra</td><td>E0</td><td>0E</td><td>sc</td><td>wn</td><td>FD</td> </tr> </table>		FE	FE	ra	E0	0E	sc	wn	FD	<table border="1"> <tr> <td>FE</td><td>FE</td><td>E0</td><td>ra</td><td>FB or FA</td><td>FD</td> </tr> </table>	FE	FE	E0	ra	FB or FA	FD
FE	FE	ra	E0	0E	sc	wn	FD									
FE	FE	E0	ra	FB or FA	FD											
<p>ra Receive address Specify a radio's address. (Section 2-5)</p> <p>E0 Transmit address Specify the controller's address, E0H.</p> <p>0E Command number Specify the command number, 0EH.</p> <p>sc Sub command number Specify the sub command number. (Section 7-11)</p> <p>wn Window number Specify a window number in BCD code. 00 or 01 can be specified.</p> <p>[Example] Starts programmed scan in window 00. If window 00 is selected as the back window, this command acts the same function as if [W-PR] is pushed. Starts window programmed scan.</p>		<p>FB OK code When the correct command is received, the radio operates as follows. Performs the specified function. Sends back the OK code, FBH.</p> <p>FA NG code Under the following conditions, the radio sends back the NG code, FAH. When the specified function could not be performed.</p>														
<table border="1"> <tr> <td>FE</td><td>FE</td><td>ra</td><td>E0</td><td>0E</td><td>02</td><td>00</td><td>FD</td> </tr> </table> <p>[Example] Starts memory scan in window 01. If window 01 is selected as the front window, this command acts the same functions as if [W-MR] and then [WINDOW] are pushed. Starts window memory scan and then changes the window.</p>		FE	FE	ra	E0	0E	02	00	FD							
FE	FE	ra	E0	0E	02	00	FD									
<table border="1"> <tr> <td>FE</td><td>FE</td><td>ra</td><td>E0</td><td>0E</td><td>22</td><td>01</td><td>FD</td> </tr> </table>		FE	FE	ra	E0	0E	22	01	FD							
FE	FE	ra	E0	0E	22	01	FD									

Command **0EH** Sub command 00H Stops all scans or a specified window scan.

■ Controller → radio

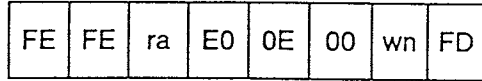

- ra** **Receive address**
Specify a radio's address. (Section 2-5)
- E0** **Transmit address**
Specify the controller's address, E0H.
- 0E** **Command number**
Specify the command number, 0EH.
- 00** **Sub command number**
Specify the sub command number, 00H.
- wn** **Window number**
Specify the window number in BCD code.

■ Radio → controller

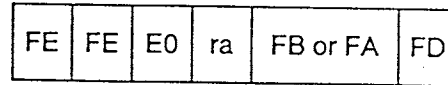

- FB** **OK code**
When the correct command is received, the radio operates as follows.
Performs the specified function.
Sends back the OK code, FBH.
- FA** **NG code**
When the radio is not equipped with the window scan function, the radio sends back NG code, FAH.

wn	Operation
—	When no window number is specified, stops all scan, including window scan.
00	Stops scan in window 00 and basic window scan. Scan in window 01 is not stopped. Even if window 01 is specified as the back window, the scan continues on the back window.
01	Stops scan in window 01 and basic window scan. Scan in window 00 is not stopped. Even if window 00 is specified as the back window, the scan continues on the back window.

7-14 Split and duplex command

Command 0FH	Selects split, simplex, +duplex or – duplex. [SPLIT, DUP]
---------------------------	---

■ Controller → radio

FE	FE	ra	E0	0F	sc	FD
----	----	----	----	----	----	----

ra **Receive address**
Specify a radio's address. (Section 2-5)

E0 **Transmit address**
Specify the controller's address, E0H.

0F **Command number**
Specify the command number, 0FH.

sc **Sub command number**
Specify the sub command number.

sc	Operation
00	Cancels split frequency operation.
01	Selects split frequency operation.
10	Cancels duplex operation.
11	Selects – duplex operation.
12	Selects +duplex operation.

■ Radio → controller

FE	FE	E0	ra	FB or FA	FD
----	----	----	----	----------	----

FB **OK code**
When the correct command is received, the radio operates as follows.
Selects split, simplex, +duplex or – duplex as specified.
Sends back the OK code, FBH.

FA **NG code**
If the radio is not equipped with the specified function, the radio sends back the NG code, FAH.

7-15 Tuning step command

Command **10H** Selects a tuning step. [TS]

■ Controller → radio

FE	FE	ra	E0	10	sc	FD
----	----	----	----	----	----	----

ra **Receive address**
Specify a radio's address. (Section 2-5)

E0 **Transmit address**
Specify the controller's address, E0H.

10 **Command number**
Specify the command number, 10H.

sc **Sub command number**
Specify the sub command number to control the following radios.

SC	Operation		
	IC-737 IC-R72	IC-R7100	IC-R9000
00	10 Hz	100 Hz	10 Hz
01	1 kHz	1 kHz	100 Hz
02	2 kHz	5 kHz	1 kHz
03	3 kHz	10 kHz	5 kHz
04	4 kHz	12.5 kHz	9 kHz
05	5 kHz	20 kHz	10 kHz
06	6 kHz	25 kHz	12.5 kHz
07	7 kHz	100 kHz	20 kHz
08	8 kHz	—	25 kHz
09	9 kHz	—	100 kHz
10	10 kHz	—	—

■ Radio → controller

FE	FE	E0	ra	FB or FA	FD
----	----	----	----	----------	----

FB **OK code**
When the correct command is received, the radio operates as follows.

When the received sub command is 00H.	Turns the [TS] switch OFF. Selects the specified tuning step. Sends back the OK code, FBH.
When the received sub command is 01H~10H.	Turns the [TS] switch ON. Selects the specified tuning step. Sends back the OK code, FBH.

FA **NG code**
When the radio is not equipped with the specified function, the radio sends back the NG code, FAH.

7-16 Other commands

Command 11H	Selects an attenuator level. [ATT]																	
■ Controller → radio	■ Radio → controller																	
<table border="1" style="display: inline-table; border-collapse: collapse;"> <tr> <td style="padding: 2px 5px;">FE</td> <td style="padding: 2px 5px;">FE</td> <td style="padding: 2px 5px;">ra</td> <td style="padding: 2px 5px;">E0</td> <td style="padding: 2px 5px;">11</td> <td style="padding: 2px 5px;">sc</td> <td style="padding: 2px 5px;">FD</td> </tr> </table>	FE	FE	ra	E0	11	sc	FD	<table border="1" style="display: inline-table; border-collapse: collapse;"> <tr> <td style="padding: 2px 5px;">FE</td> <td style="padding: 2px 5px;">FE</td> <td style="padding: 2px 5px;">E0</td> <td style="padding: 2px 5px;">ra</td> <td style="padding: 2px 5px;">FB or FA</td> <td style="padding: 2px 5px;">FD</td> </tr> </table>	FE	FE	E0	ra	FB or FA	FD				
FE	FE	ra	E0	11	sc	FD												
FE	FE	E0	ra	FB or FA	FD													
<table border="1" style="display: inline-table; border-collapse: collapse; vertical-align: top;"> <tr> <td style="padding: 2px 5px; text-align: center;">ra</td> <td style="padding: 5px;">Receive address Specify a radio's address. (Section 2-5)</td> </tr> <tr> <td style="padding: 2px 5px; text-align: center;">E0</td> <td style="padding: 5px;">Transmit address Specify the controller's address, E0H.</td> </tr> <tr> <td style="padding: 2px 5px; text-align: center;">11</td> <td style="padding: 5px;">Command number Specify the command number, 11H.</td> </tr> <tr> <td style="padding: 2px 5px; text-align: center;">sc</td> <td style="padding: 5px;">Sub command number Specify the sub command number to control following radios.</td> </tr> </table>	ra	Receive address Specify a radio's address. (Section 2-5)	E0	Transmit address Specify the controller's address, E0H.	11	Command number Specify the command number, 11H.	sc	Sub command number Specify the sub command number to control following radios.	<table border="1" style="display: inline-table; border-collapse: collapse; vertical-align: top;"> <tr> <td style="padding: 2px 5px; text-align: center;">FB</td> <td style="padding: 5px;">OK code When the correct command is received, the radio operates as follows. Selects the specified attenuator level. Sends back the OK code, FBH.</td> </tr> <tr> <td style="padding: 2px 5px; text-align: center;">FA</td> <td style="padding: 5px;">NG code When the radio is not equipped with attenuator level selection capability, the radio sends back NG code, FAH.</td> </tr> </table>	FB	OK code When the correct command is received, the radio operates as follows. Selects the specified attenuator level. Sends back the OK code, FBH.	FA	NG code When the radio is not equipped with attenuator level selection capability, the radio sends back NG code, FAH.					
ra	Receive address Specify a radio's address. (Section 2-5)																	
E0	Transmit address Specify the controller's address, E0H.																	
11	Command number Specify the command number, 11H.																	
sc	Sub command number Specify the sub command number to control following radios.																	
FB	OK code When the correct command is received, the radio operates as follows. Selects the specified attenuator level. Sends back the OK code, FBH.																	
FA	NG code When the radio is not equipped with attenuator level selection capability, the radio sends back NG code, FAH.																	
<table border="1" style="border-collapse: collapse; width: 100%;"> <thead> <tr> <th rowspan="2" style="padding: 5px;">sc</th> <th colspan="2" style="padding: 5px;">Operation</th> </tr> <tr> <th style="padding: 5px;">IC-R7100</th> <th style="padding: 5px;">IC-R9000</th> </tr> </thead> <tbody> <tr> <td style="padding: 5px; text-align: center;">00</td> <td style="padding: 5px;">Turns the attenuator OFF.</td> <td style="padding: 5px;">Turns the attenuator OFF.</td> </tr> <tr> <td style="padding: 5px; text-align: center;">10</td> <td style="padding: 5px; text-align: center;">——</td> <td style="padding: 5px;">Selects 10 dB attenuator.</td> </tr> <tr> <td style="padding: 5px; text-align: center;">20</td> <td style="padding: 5px;">Selects 20 dB attenuator.</td> <td style="padding: 5px;">Selects 20 dB attenuator.</td> </tr> <tr> <td style="padding: 5px; text-align: center;">30</td> <td style="padding: 5px; text-align: center;">——</td> <td style="padding: 5px;">Selects 30 dB attenuator.</td> </tr> </tbody> </table>		sc	Operation		IC-R7100	IC-R9000	00	Turns the attenuator OFF.	Turns the attenuator OFF.	10	——	Selects 10 dB attenuator.	20	Selects 20 dB attenuator.	Selects 20 dB attenuator.	30	——	Selects 30 dB attenuator.
sc	Operation																	
	IC-R7100	IC-R9000																
00	Turns the attenuator OFF.	Turns the attenuator OFF.																
10	——	Selects 10 dB attenuator.																
20	Selects 20 dB attenuator.	Selects 20 dB attenuator.																
30	——	Selects 30 dB attenuator.																

Command 12H Turns ON/OFF the antenna switch or selects an antenna connector.

■ Controller → radio

Operation differs according to a radio.

- For the IC-737 : Selects the [ANT 1] or [ANT 2] connector.
- For the IC-9000 : Turns ON or OFF the antenna switch.

FE	FE	ra	E0	12	sc	FD
----	----	----	----	----	----	----

- ra** **Receive address**
Specify a radio's address. (Section 2-5)
- E0** **Transmit address**
Specify the controller's address, E0H.
- 12** **Command number**
Specify the command number, 12H.
- sc** **Sub command number**
Specify the sub command number to control following radios.

sc	Operation	
	IC-737	IC-R9000
00	Selects the [ANT 1] connector.	Turns the antenna switch OFF.
01	Selects the [ANT 2] connector.	Turns the antenna switch ON.

■ Radio → controller

FE	FE	E0	ra	FB or FA	FD
----	----	----	----	----------	----

- FB** **OK code**
When the correct command is received, the radio operates as follows.
 - Turns ON or OFF the antenna switch.
 - Sends back the OK code, FBH.
- FA** **NG code**
Under the following conditions, the radio sends back the NG code, FAH.
 - When the radio is not equipped with the antenna input ON/OFF function.
 - When the radio is not equipped with the antenna selection function.
 - For the IC-737, in SET mode, the antenna switch setting "Ant SEL" is "oFF."

NOTE: Previous settings are required as following:

- For the IC-737: In SET mode, select the antenna switch setting "Ant SEL" to "on." Refer to p. 32 of the IC-737 instruction manual.
- For the IC-R9000: Operation differs according to the HF antenna switch on rear panel. Refer to pgs. 5 and 7 of the IC-R9000 instruction manual.

Command 13H An optional voice synthesizer unit announces the frequency and mode. [SPEECH]

■ **Controller → radio**

FE	FE	ra	E0	13	sc	FD
----	----	----	----	----	----	----

- ra** **Receive address**
Specify a radio's address. (Section 2-5)
- E0** **Transmit address**
Specify the controller's address, E0H.
- 13** **Command number**
Specify the command number, 13H.
- sc** **Sub command number**
Specify the sub command number to control the IC-R72, IC-R7100 and IC-R9000.

sc	Operation
00	Announces all data.
01	Announces frequency data only.

NOTE: For the IC-R72, IC-R7100 and IC-R9000, an optional voice synthesizer announces frequency data even though it accepts sub command 00H.

■ **Radio → controller**

FE	FE	E0	ra	FB or FA	FD
----	----	----	----	----------	----

- FB** **OK code**
When the correct command is received, the radio operates as follows.
Announces the specified data for an optional voice synthesizer unit.
Sends back the OK code, FBH.
- FA** **NG code**
When the specified sub command is wrong, the radio sends back the NG code, FAH.

Command **14H** Selects the AF gain, RF gain or squelch level.

■ Controller → radio

FE	FE	ra	E0	14	sc	gd	FD
----	----	----	----	----	----	----	----

- ra** **Receive address**
Specify a radio's address. (Section 2-5)
- E0** **Transmit address**
Specify the controller's address, E0H.
- 14** **Command number**
Specify the command number, 14H.
- sc** **Sub command number**
Specify the sub command number to control the IC-R7100 and IC-R9000.

sc	Operation
01	Selects the AF gain level.
02	Selects the RF gain level.
03	Selects the squelch level.

- gd** **Gain or level data**
Specify the gain or level in BCD code. (Section 1-10) 32 levels are selectable.

gd	Gain or level
00~07	0
08~15	1
16~23	2
24~31	3
⋮	⋮
96~0103	12
0104~0111	13
⋮	⋮
0248~0255	31

[Example] Selects AF gain level 0108.

FE	FE	ra	E0	14	01	01	08	FD
----	----	----	----	----	----	----	----	----

■ Radio → controller

FE	FE	E0	ra	FB or FA	FD
----	----	----	----	----------	----

- FB** **OK code**
When the correct command is received, the radio operates as follows:

When the [REMOTE] switch is OFF.	Selects the specified level. Selects the 2 unspecified levels to their initial settings. Turns the [REMOTE] switch ON. Sends back the OK code, FBH.
When the [REMOTE] switch is ON.	Selects the specified level. Sends back the OK code, FBH.

- FA** **NG code**
Under the following conditions, the radio sends back the NG code, FAH.
The radio is not equipped with the specified function.
Specified gain or level is wrong.

NOTE: When remote mode is selected, AF gain, RF gain and squelch level control can only be performed via the controller.

To cancel the remote mode, push the [REMOTE] switch on the radio.

For the IC-R7100, only the AF gain level can be controlled via the controller.

Command 15H Reads out squelch status data and signal strength data.

■ Controller → radio

FE	FE	ra	E0	15	sc	FD
----	----	----	----	----	----	----

- ra** **Receive address**
Specify a radio's address. (Section 2-5)
- E0** **Transmit address**
Specify the controller's address, E0H.
- 15** **Command number**
Specify the command number, 15H.
- sc** **Sub command number**
Specify the sub command number the IC-R7100 and IC-R9000.

sc	Operation
01	Reads out whether the squelch is open or closed.
02	Reads out signal strength.

■ Radio → controller

FE	FE	E0	ra	15	sc	sd	FD
----	----	----	----	----	----	----	----

- E0** **Receive address**
The radio automatically specifies the controller's address, E0H.
- ra** **Transmit address**
The radio automatically specifies its address.
- 15** **Command number**
The radio automatically specifies the received command number, 15H.
- sc** **Sub command number**
The radio automatically specifies the received sub command number.
- sd** **Status data**
For sub command 01:
The radio sends back the squelch status in BCD code.

[Example] When the squelch is closed.

$$\boxed{sd} = \boxed{00}$$

[Example] When the squelch is open.

$$\boxed{sd} = \boxed{01}$$

For sub command 02:

The radio sends back the signal strength data in BCD code.

[Example] When signal strength is 0234.

$$\boxed{sd} = \boxed{02} \boxed{34}$$

If the radio is not equipped with the specified function, the radio sends back the NG code, FAH.



**ICOM
COMPUTER INTERFACING
SUPPLEMENT**

(1) Preface

There are seven data lines on the ACC socket for remote control.

The computer data will be exchanged by four I/O data lines, DB1~DB8.

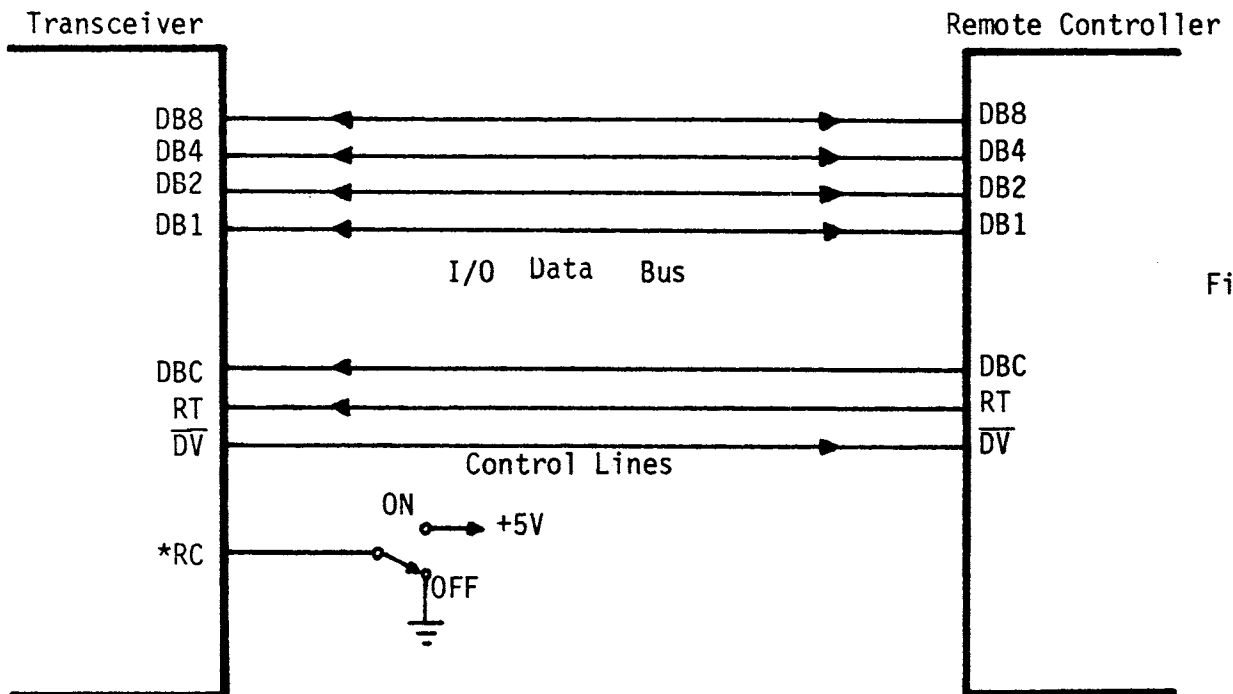

Fig. 1

*RC line is used only on the IC-720 and IC-720A.

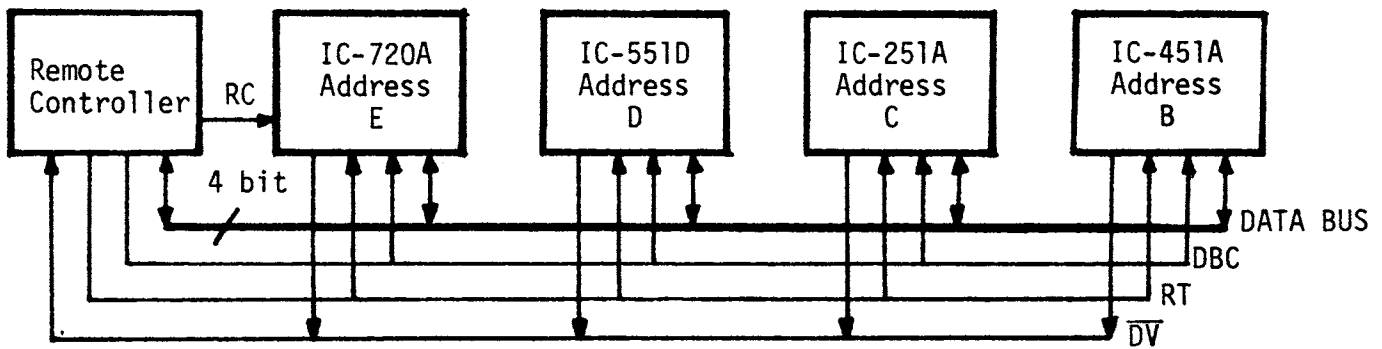

Fig. 2 (see Note 1)

Transceivers which can be remotely controlled.

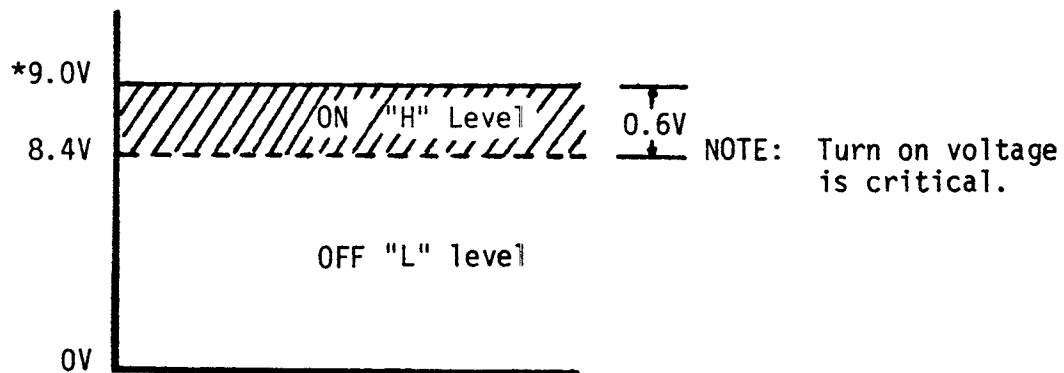

Fig. 3

P-mos micro-computer "H" level

IC-551, IC-551D	}	* "H" level = +9VDC
IC-255A		
IC-451A		
IC-251A		
IC-260A		
IC-560		

IC-720, IC-720A "H" level = +5VDC (C-MOS level)

NOTE 1: For parallel control of all the transceivers from the same data bus, there must be a 9V to 5V converter installed in the IC-720A data lines.

(2) Control Line Designators

1. \overline{DV} (data-valid)

This line goes L-level if the data entered is valid.

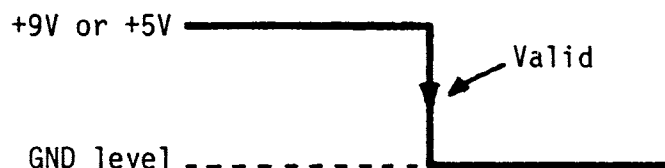

Fig. 4

2. DBC (data-bus-control)

The DBC pulse is initiated by the controller to the transceiver at H-level and the reply from the transceiver to the controller is at L-level.

3. RT (Remote-trigger)

Preparing to send to the data from the transceiver to the remote controller when RT line is "H" level. Then, the data will be sent from the transceiver to the remote controller when both DBC and RT are "H" level.

DBC	RT	Remarks
L	L	Stand by
H	L	Preparing to send address data
L	H	Preparing to receive address data or to send data from the transceiver to the remote controller.
H	H	Preparing to send data from the controller to the transceiver.

Table 1

4. RC (Remote-control)

This bus is used with only IC-720 or IC-720A.

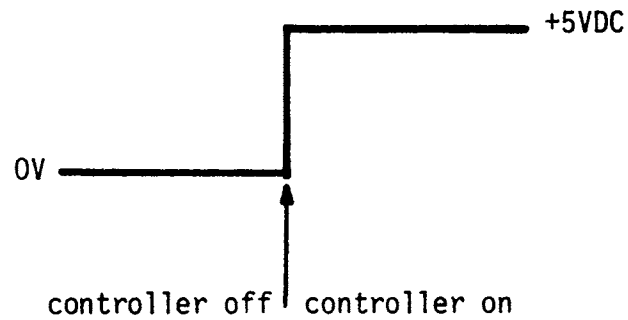

Fig. 5

5. DB1, DB2, DB4, DB8 (Data-bus)

These constitute a parallel "BCD" port.

(Data-bus)	(BCD data)
DB 1	1
DB 2	2
DB 4	4
DB 8	8

(3) 1. Address

Set the data as follows:

Band	*Code	DB1	DB2	DB4	DB8	Model
HF	E	L	H	H	H	IC-720 IC-720A
50MHz	D	H	L	H	H	IC-551D IC-560 IC-551
144MHz	C	L	L	H	H	IC-255A IC-251A IC-260
430MHz	B	H	H	L	H	IC-451A

*Hexadecimal

Table 2

The transceiver will accept address data from the remote controller if the address is valid.

2. How to send address data.

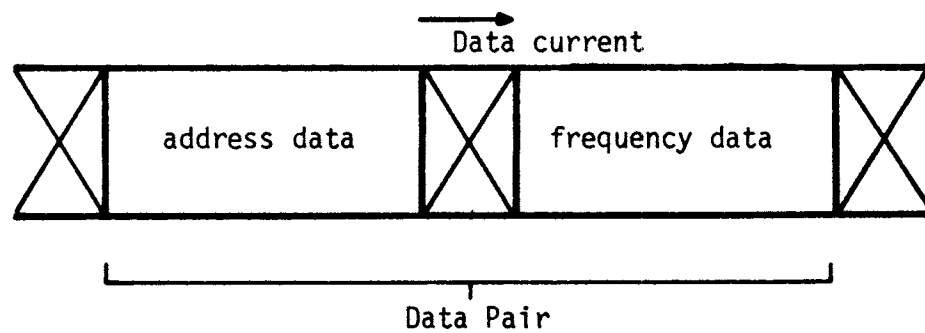

Fig. 6

Example 1

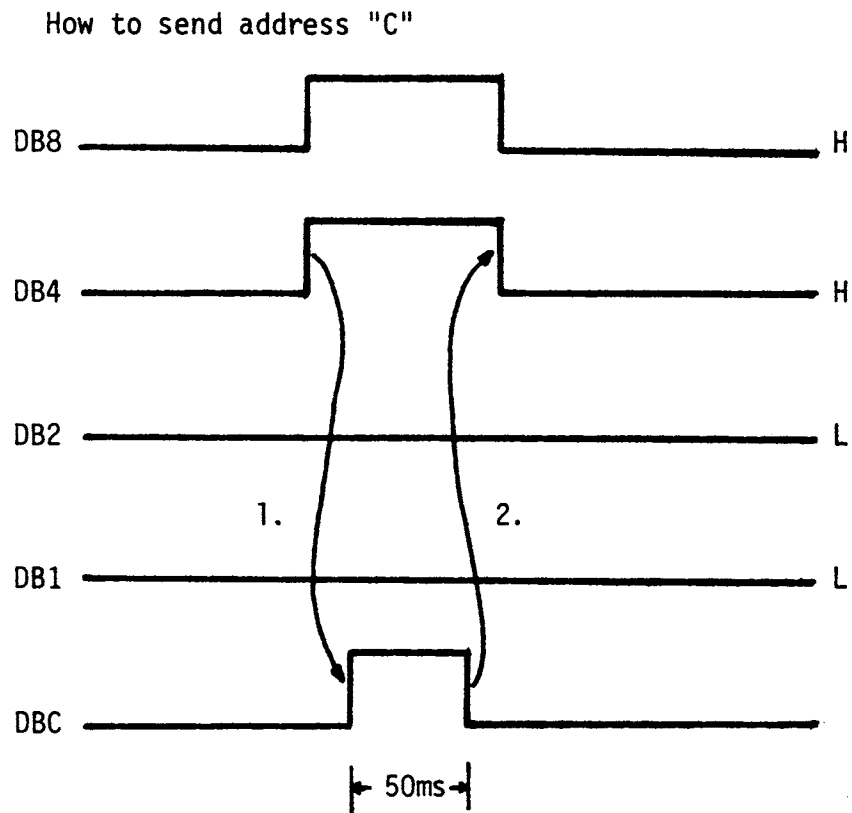

Fig. 7

1. Send address data "C".
Apply "H" level to DBC line for 50 msec.
2. Remove the DBC pulse and the data bus is cleared.

Example 2

How to send address data B.

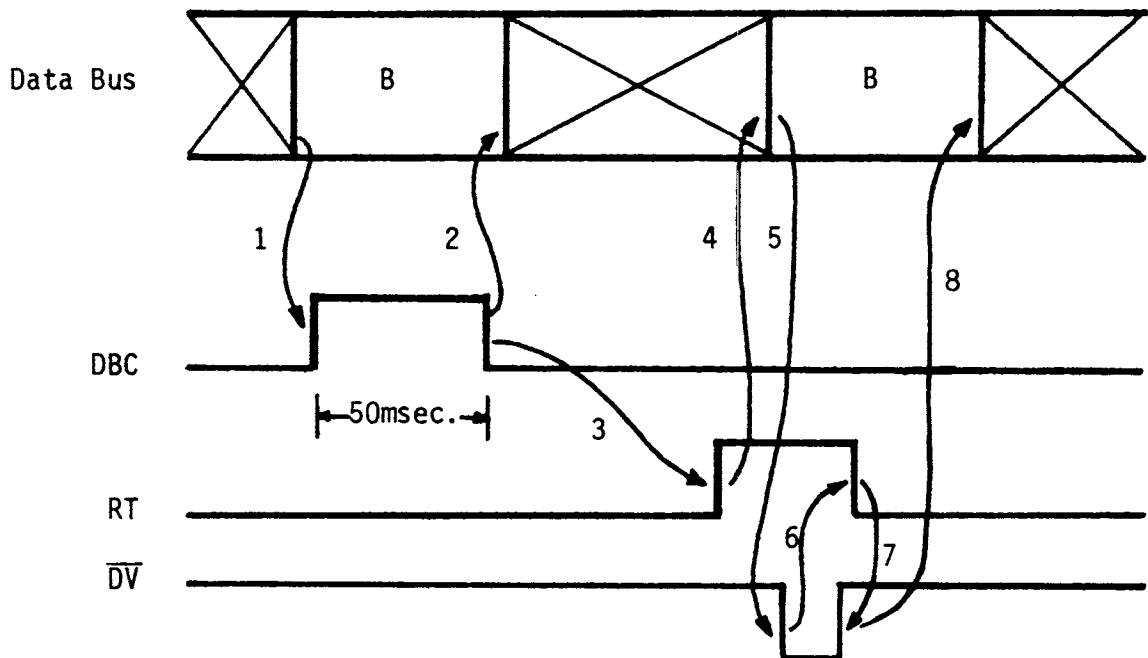

Fig. 8

- 1 & 2. Send the data pair as per example and apply the DBC load pulse for 50msec.
3. Apply RT pulse for "H" level after the DBC pulse.
4. The transceiver will respond with the "B" address data when RT becomes "H" level.
5. \overline{DV} will be low level to indicate valid data.
6. Apply "L" level \overline{DV} pulse when RT is "L" level.
7. Apply "L" level RT pulse when \overline{DV} is "H" level.
8. The data on the data bus will be cleared when \overline{DV} becomes "H" level.

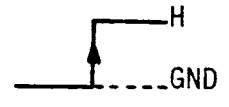
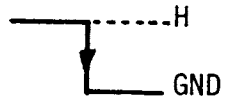
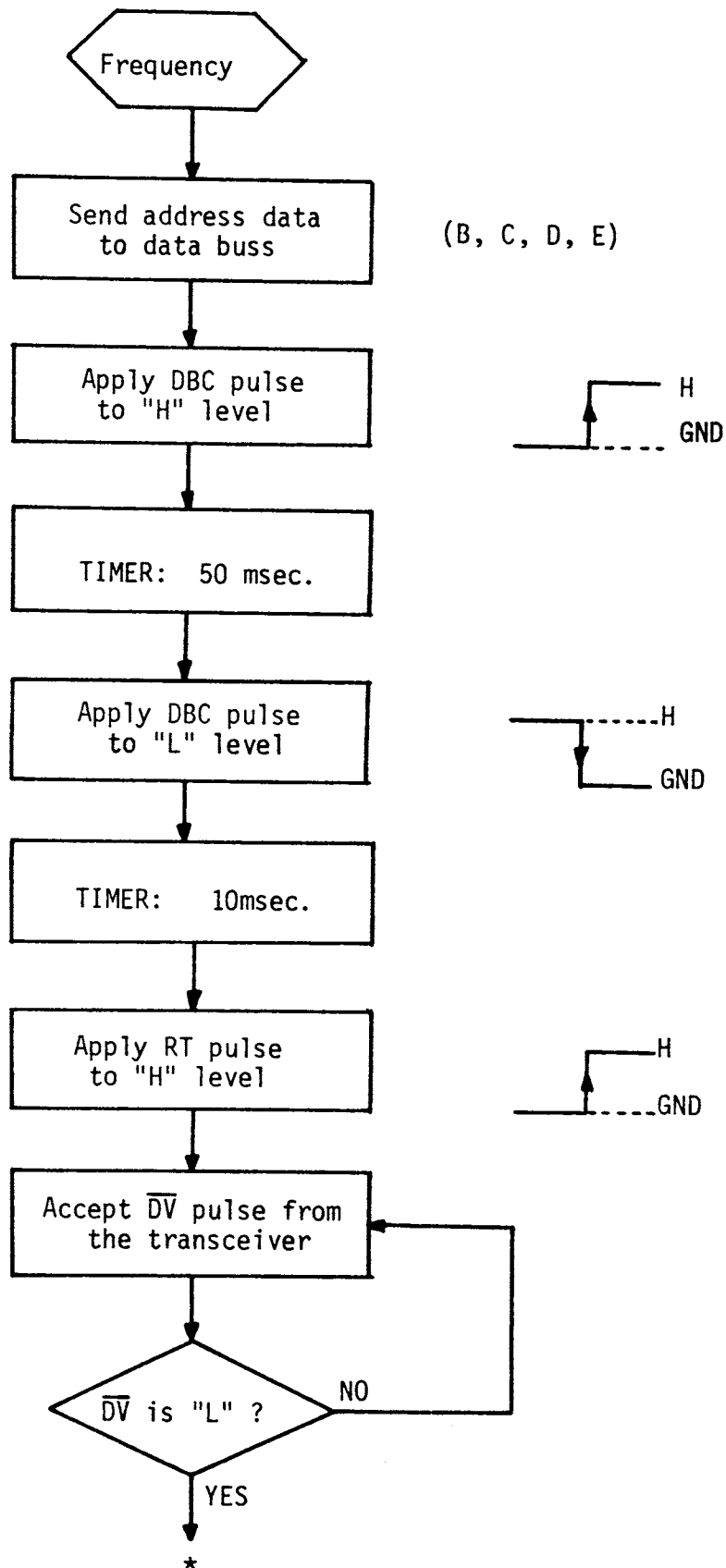

Fig. 9-A

(4) Control Flowchart (cont.)

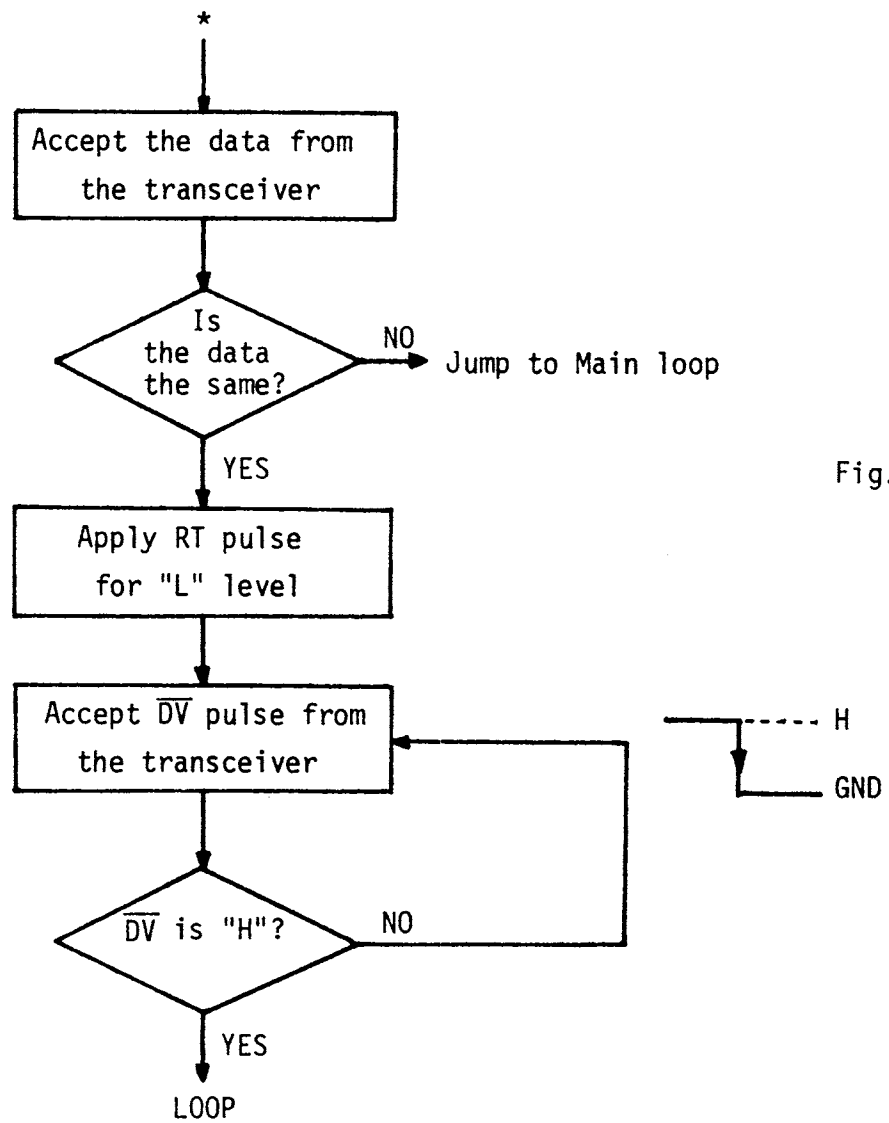

Fig. 9-B

Example 3

Sending address and frequency data for the 50MHz band.

1. Send address data "D" from the remote controller to the transceiver as per Example 2.

The remote controller will receive "D" address data from the transceiver if the address data is valid. Refer to Example 2 which illustrates sending address data.

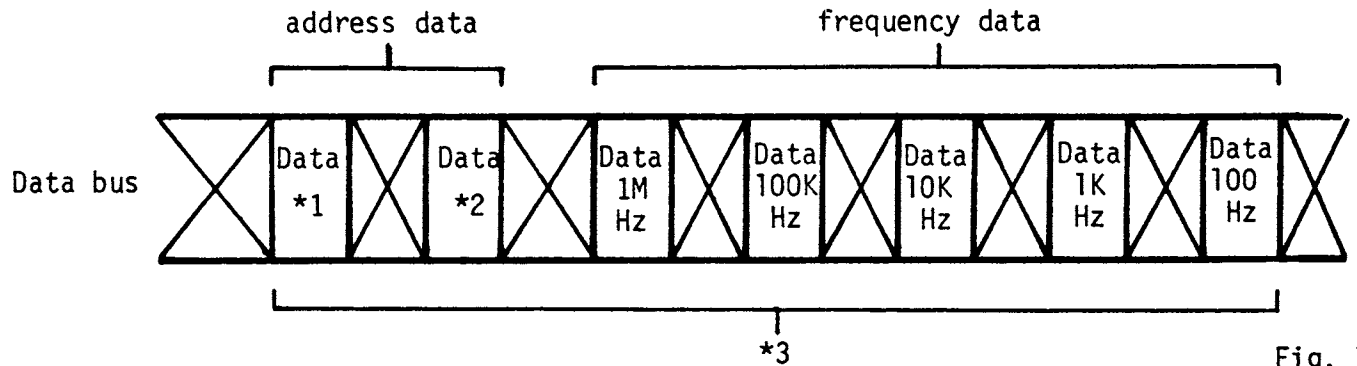
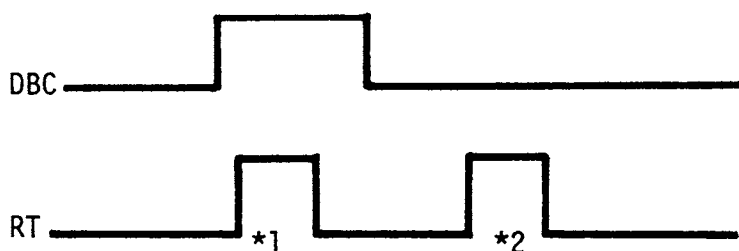

Fig. 10

- NOTE: *1: This data is from the controller to the transceiver.
 *2: This data is from the transceiver to the controller.
 *3: This constitutes a data pair.

2. Sequentially send the frequency data (A-E) after receiving Data *2 from the transceiver. Refer to Fig. 10.
3. The DBC and RT pulses are needed when sending frequency data from the remote controller to the transceiver. Refer to (5).
4. RT is needed when sending frequency data from the transceiver to the remote controller. Refer to (5) which illustrates sending frequency data.

Fig. 11



- *1 The pulse is from remote controller to the transceiver.
 *2 The pulse is from the transceiver to the controller.

- (5) Sending frequency data from the remote controller to the transceiver.

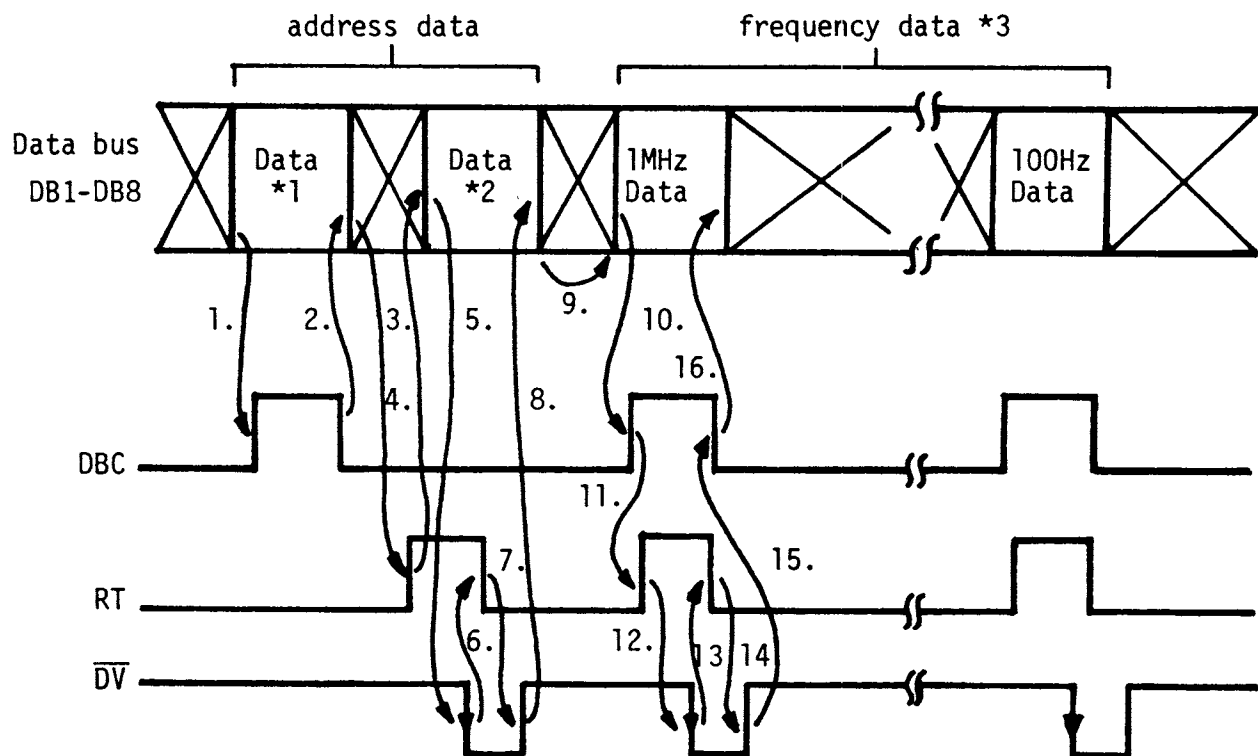

Fig. 12

- NOTE: *1: This data is from the remote controller to the transceiver.
 *2: This data is the response from the transceiver to the remote controller.
 *3: Frequency data is sent in sequential bits.

1. Send the address data (B, C, D, E) from the remote controller to the transceiver. Set the DBC line to "H" level after the address is sent.
2. Clear the data bus lines after applying the 50msec. DBC pulse.
3. Apply the RT pulse for "H" level after setting the DBC pulse to "L" level.
4. The remote controller will receive the address data from the transceiver if the address data is valid.
5. In response, the transceiver will set the \overline{DV} line for "L" level to indicate a valid address.
6. Set the RT pulse to "L" level after the \overline{DV} line is "L" level.
7. The transceiver will set the \overline{DV} line to "H" level after RT becomes "L" level.
8. After processing, the transceiver will clear the address data on the data bus.
9. Send the BCD data for MHz digit from the controller to the transceiver.

(5) Sending frequency data from the remote controller to the transceiver (cont.).

10. Set DBC pulse to "H" level.

11. Set RT pulse to "H" level.

12. The transceiver will set the \overline{DV} line to "L" level after receiving the data.

13. Set RT pulse to "L" level after \overline{DV} is "L" level.

14. The transceiver will set \overline{DV} to "H" level after RT is "L" level.

15. Set the DBC pulse to "L" level after \overline{DV} becomes "H" level.

16. After step 15, the remote controller will clear the data bus.

NOTE: Refer to Examples 1 - 3 concerning 1 to 8. The process from 9 to 16 is for only one frequency digit. Therefore, four more entries must be made.

17. Return to step 9 to send the next digit.

(6) Sending frequency data from the transceiver to remote controller.

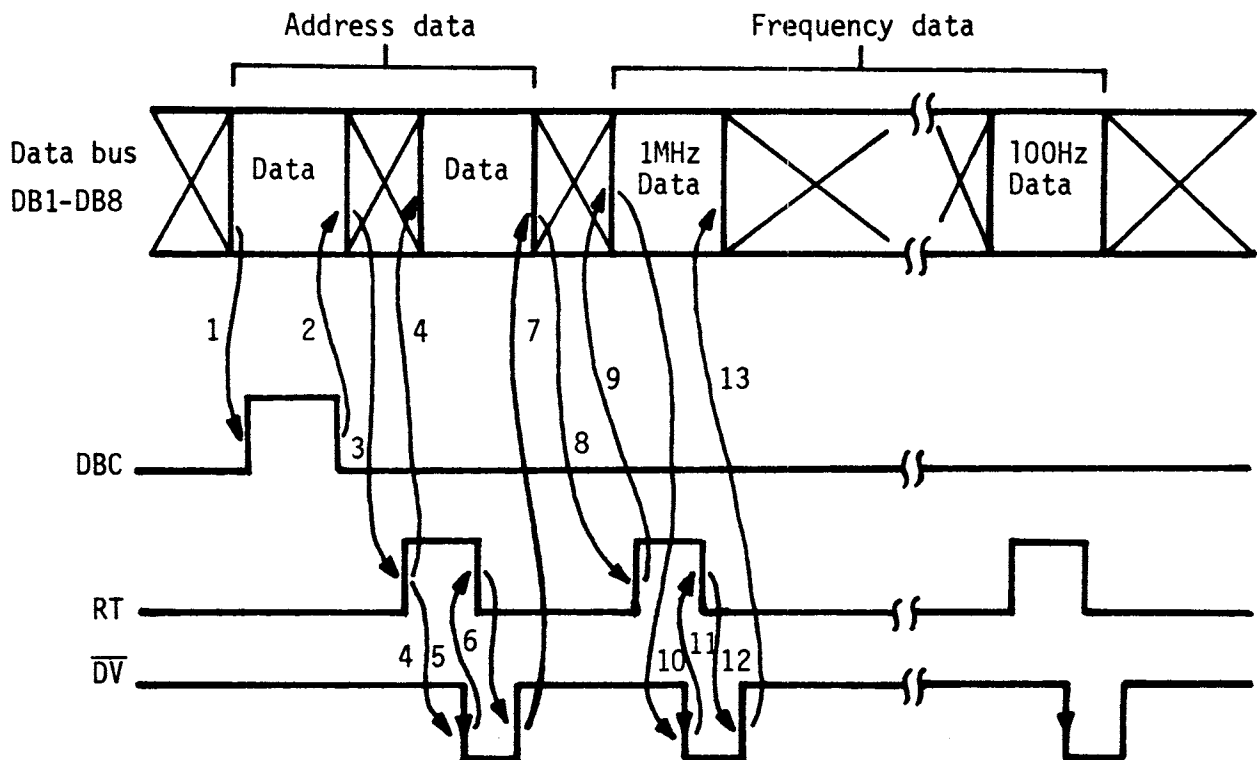

Fig. 13

1. Send the address data (B, C, D, E) from the remote controller to the transceiver and apply the DBC pulse for "H" level for 50msec.
2. Clear the data on the data bus after applying the DBC pulse from "H" level to "L" level.
3. Apply the RT pulse for "H" level.
4. The remote controller will receive the address data from the transceiver if the address data is valid and the transceiver will set the \overline{DV} line to "L" level to show that the address data is valid.
5. Apply the RT pulse for "L" level after \overline{DV} becomes "L" level.
6. The \overline{DV} line will be "H" level after RT is "L" level.
7. The transceiver will clear data after \overline{DV} is "H" level.
8. Apply RT pulse for "H" level.
9. The transceiver will output frequency data on the data bus when RT is "H" level.
10. The transceiver will set the \overline{DV} pulse to "L" level to show the data is

valid, immediately after the data is outputted.

11. Set RT pulse to "L" level after \overline{DV} is "L" level.
12. The transceiver will set the \overline{DV} line to "H" level after RT is "L" level.
13. Therefore, the data on the data bus is cleared.

NOTE: Sequentially send the frequency data 100KHz to 100Hz in like fashion as 8 to 13.

Example 5

Sending data for 145.1234MHz from the remote controller to the transceiver.

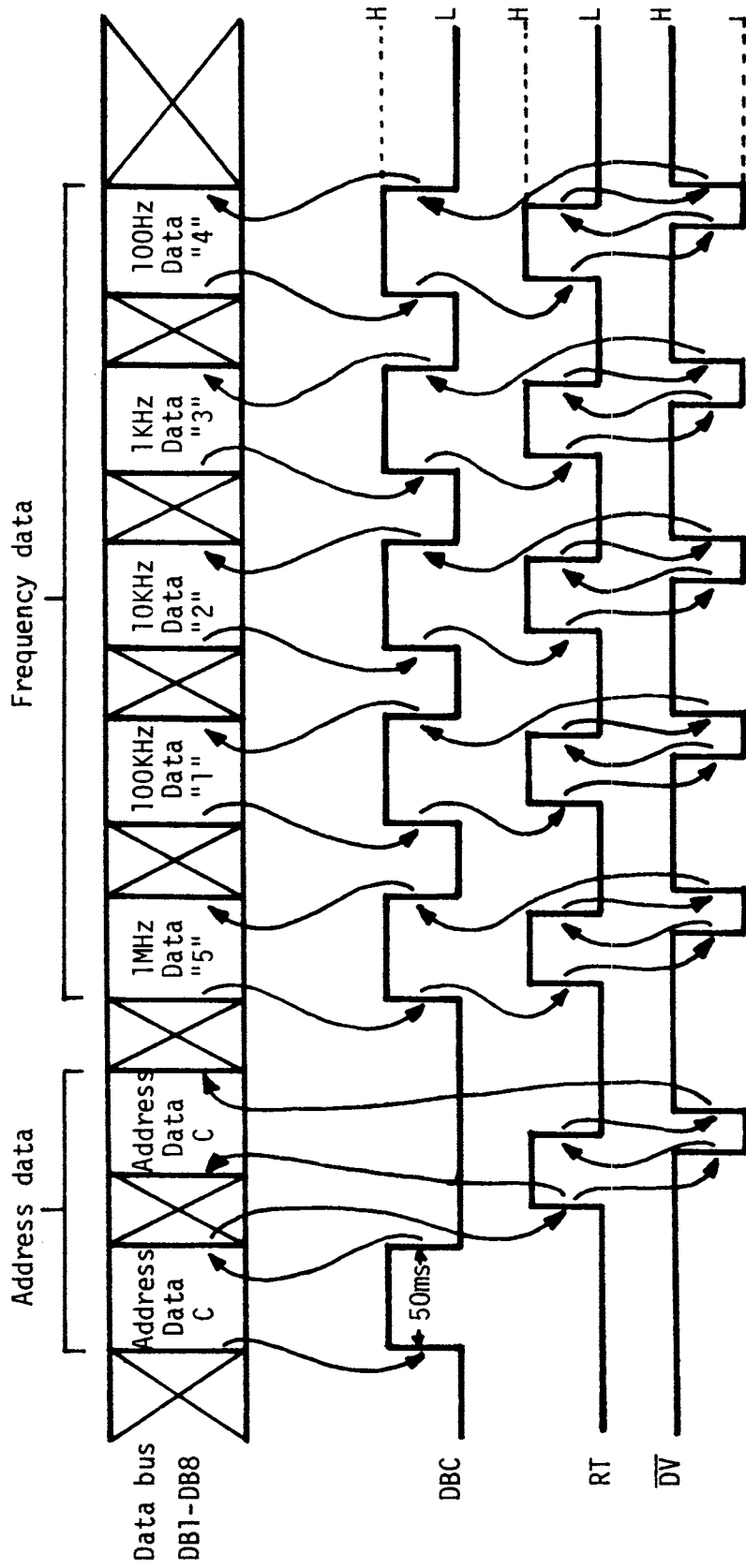

Fig. 14

(7) Sending data to the IC-720 and IC-720A.

Send the address data and frequency data as in Example 4.

Mode and VFO data must also be sent.

1. Data sequence is:

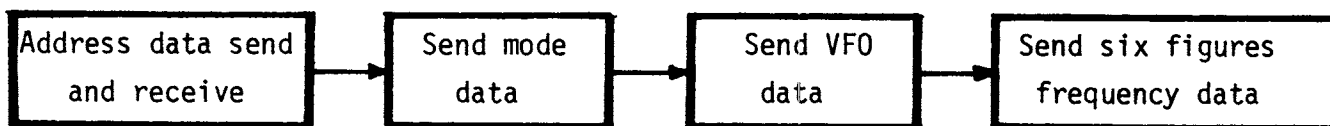

NOTE: RC is needed for HF only.

Fig. 15

2. Mode and VFO data:

Display	*Data for computer	*Hexadecimal
USB	0	
CW	6	
AM	8	
RTTY	C	
LSB	B	
VFO A	A	
VFO B	B	

Table 3

3. Notes when using with the IC-720 and IC-720A:

- Set HAM/GEN button to GEN (general coverage) position.
- Do not turn the tuning knob or depress any front panel controls during the data sending process.
- Apply +5 volts to pin #18 (RC) on the ACC plug for remote operation.
- Send address and frequency data once from the remote controller to the transceiver if only changing frequency on the same band. (See Fig.

16) Send address and frequency data twice from the remote controller to the transceiver if changing frequency on a different band. (See Fig. 17)

*1

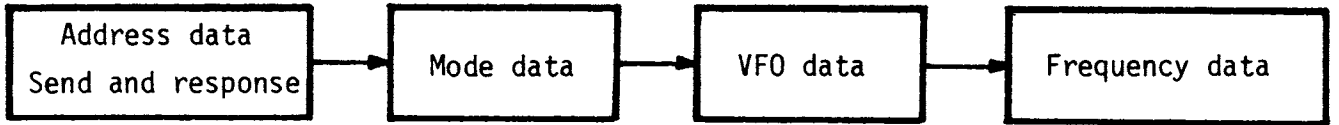

Fig. 16

*2

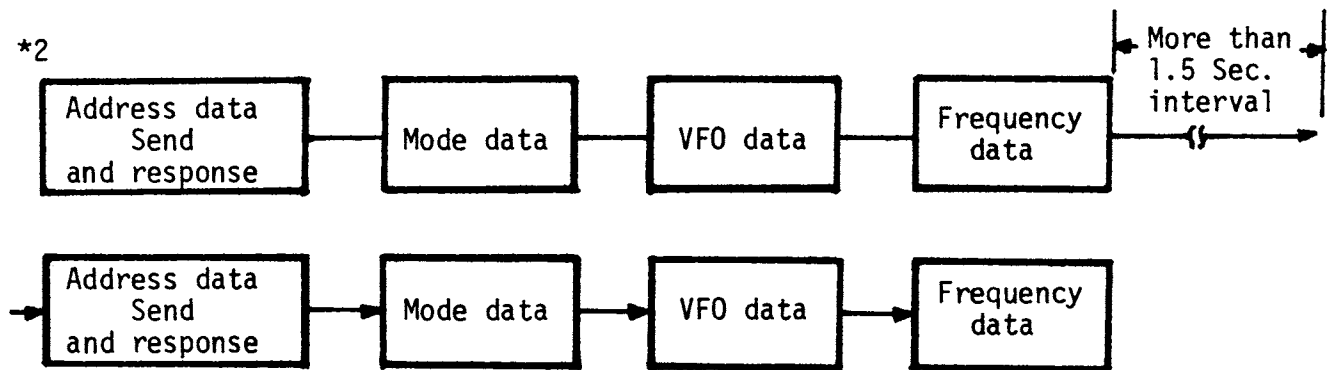

Fig. 17

NOTE: 10Hz data should not be inputted.

(8) Timing chart for sending data to the IC-720 and IC-720A.

1. From the remote controller to the transceiver.

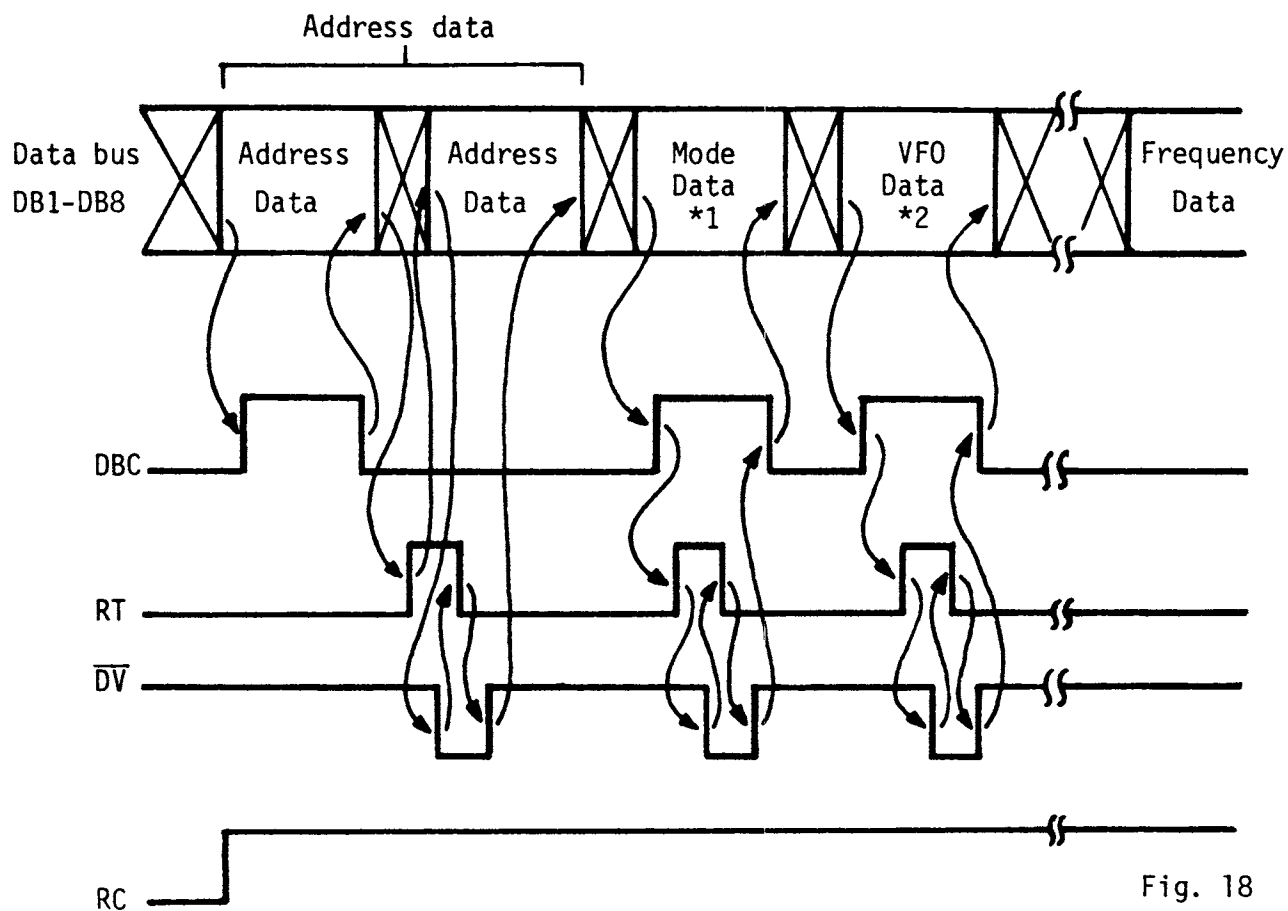

Fig. 18

*1 & *2: Mode data and VFO data are needed after the response address data from the transceiver.

2. From the transceiver to the remote controller.

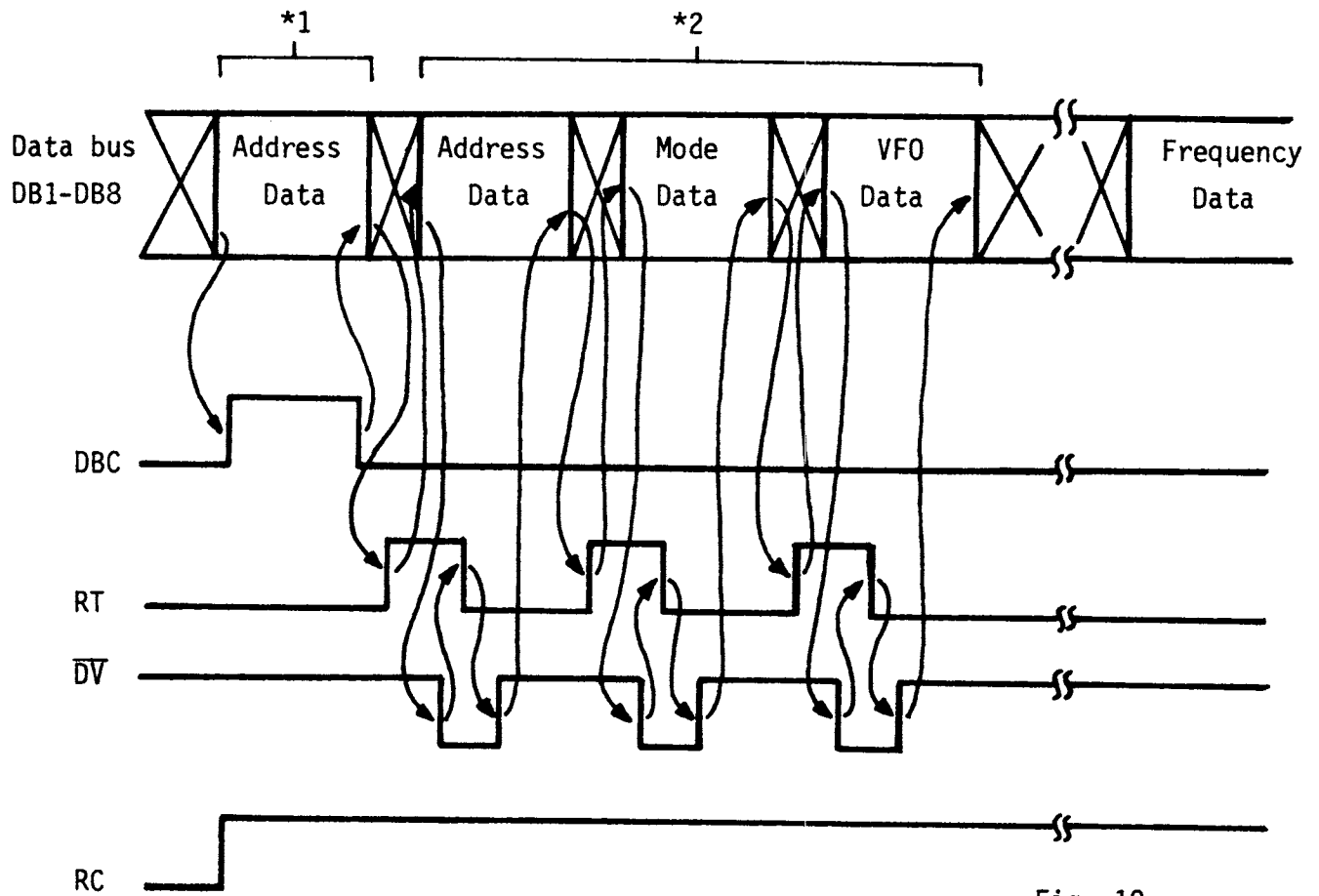

Fig. 19

*1 From the remote controller to the transceiver.

*2 From the transceiver to the remote controller.

NOTE: The examples given and the schematic of the manual remote controller are for reference aids only. It is left to the user to generate all software required.

CONTROLLER SCHEMATIC

(For IC-551, IC-551D, IC-560, IC-251A, IC-260 and IC-255A)

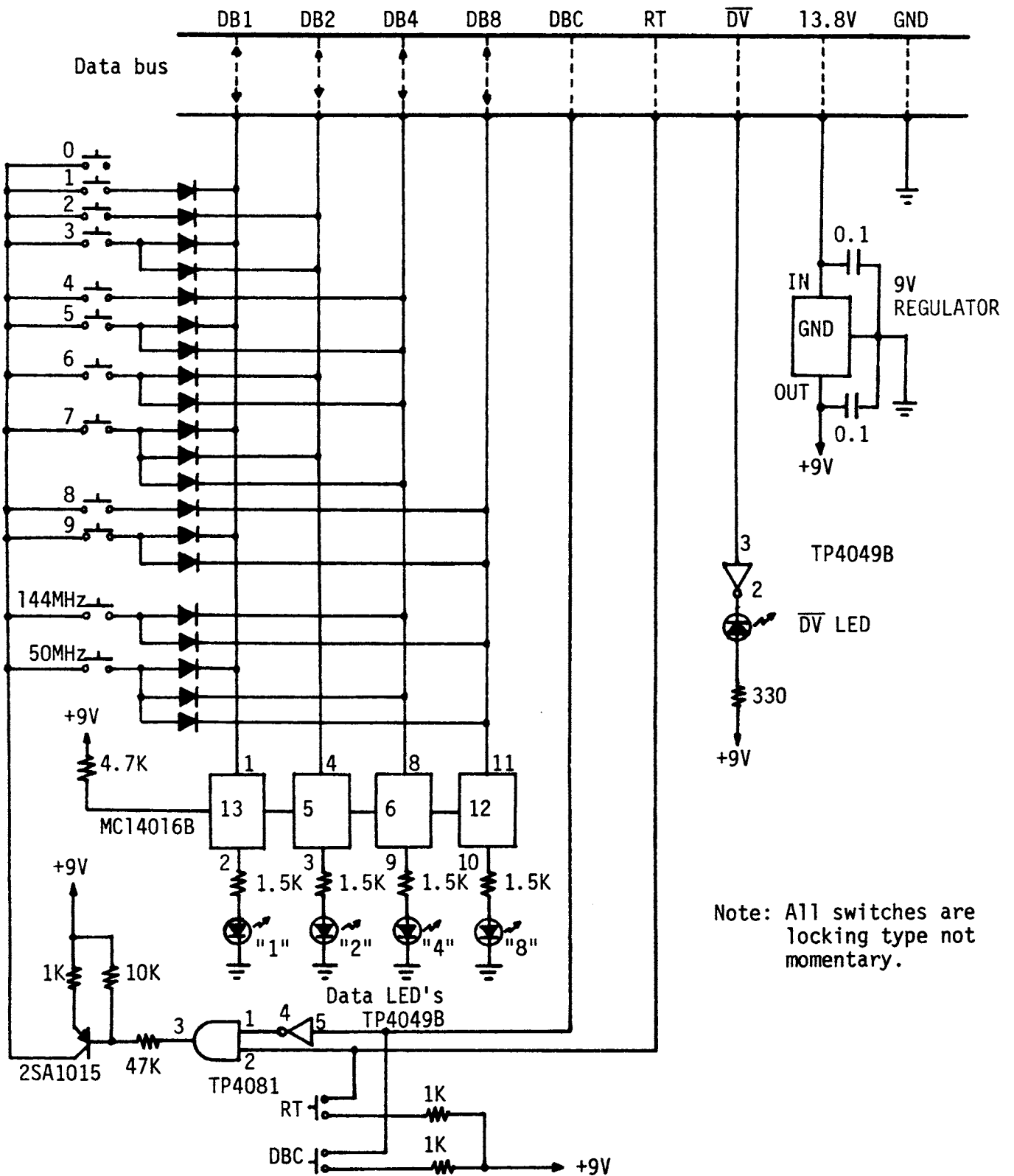

Note: All switches are locking type not momentary.

Fig. 20

REMOTE JACK (CI-V) INFORMATION

IC-706
IC-706HXII

◆ CI-V connection example

The transceiver can be connected through an optional CT-17 LEVEL CONVERTER to a personal computer equipped with an RS-232C port. The Icom Communication interface-V (CI-V) controls the following functions of the transceiver.

Up to four Icom CI-V transceivers or receivers can be connected to a personal computer equipped with an RS-232C port. See p. 45 for setting the CI-V condition using initial set mode.

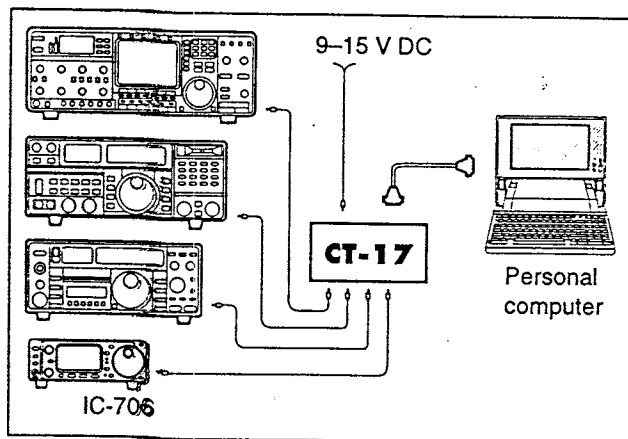

◆ Data format

The CI-V system can be operated using the following data formats. Data formats differ according to command numbers. A data area is added for some commands.

CONTROLLER TO IC-706

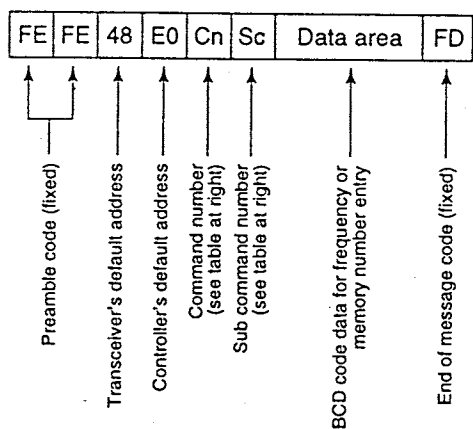

OK MESSAGE TO CONTROLLER

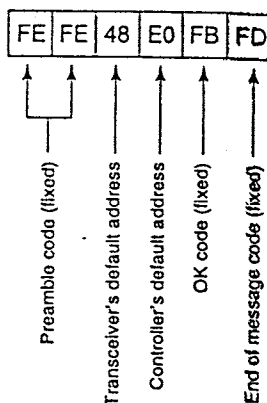

COMMAND TABLE

Description	Cn	Sc	
Frequency control	05	Data	
Operating mode and IF filter control	06	LSB	00**
		USB	01**
		AM	02**
		CW	03**
		RTTY	04**
		FM	05**
WFM	06		
VFO mode		-	
VFO A	07	00	
VFO B		01	
A=B		A0	
A/B		B0	
Memory mode	08	-	
Memory selection		mc**	
Memory write	09	-	
Memory to VFO	0A	-	
Memory clear	0B	-	
Scan stop	0E	00	
Scan start		01	
Split OFF	0F	00	
Split ON		01	
[TS] OFF (10 Hz step)	10	00	
[TS] ON			
100 Hz step		01	
1 kHz step		02	
5 kHz step		03	
9 kHz step		04	
10 kHz step		05	
12.5 kHz step		06	
20 kHz step		07	
25 kHz step		08	
100 kHz step	09		

IC-706 TO CONTROLLER

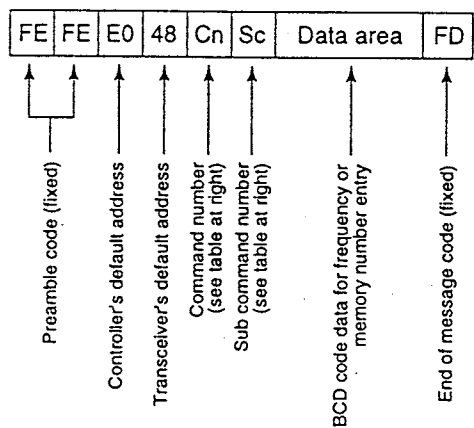

NG MESSAGE TO CONTROLLER

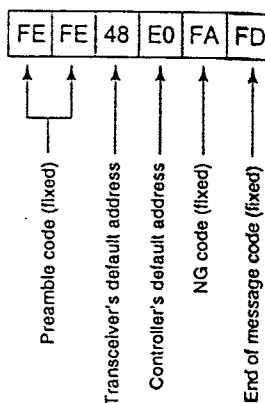

*Add "02" to select narrow IF filters.
 **Memory channel number (BCD)
 P1=0100, P2=0101.

IC-706MKII

10-2

◆ CI-V connection example

The transceiver can be connected through an optional CT-17 CI-V LEVEL CONVERTER to a personal computer equipped with an RS-232C port. The Icom Communication interface-V (CI-V) controls the following functions of the transceiver.

Up to four Icom CI-V transceivers or receivers can be connected to a personal computer equipped with an RS-232C port. See p. 55 for setting the CI-V condition using initial set mode.

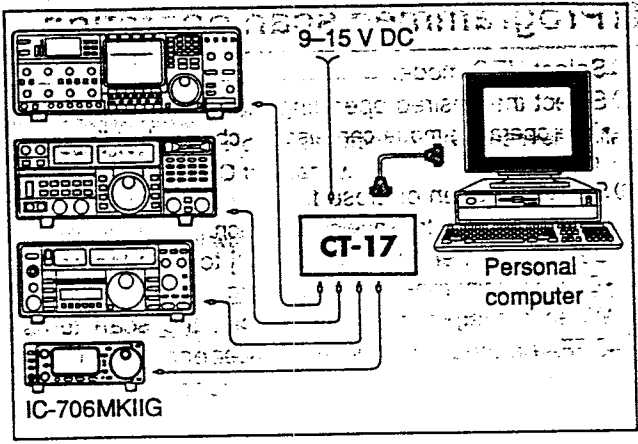

◆ Data format

The CI-V system can be operated using the following data formats. Data formats differ according to command numbers. A data area is added for some commands.

CONTROLLER TO IC-706MKIIIG

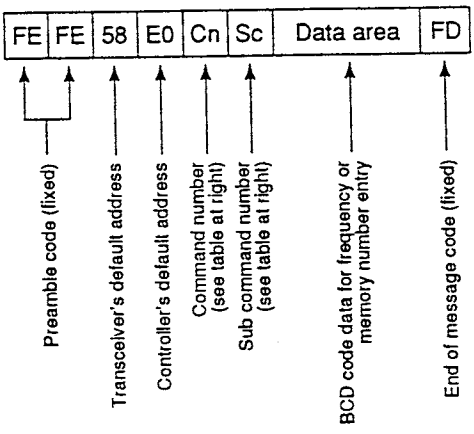

OK MESSAGE TO CONTROLLER

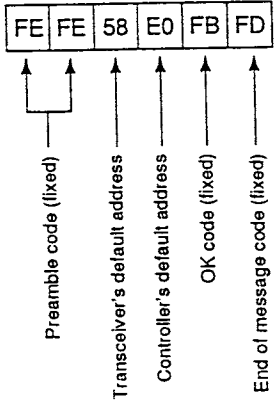

IC-706MKIIIG TO CONTROLLER

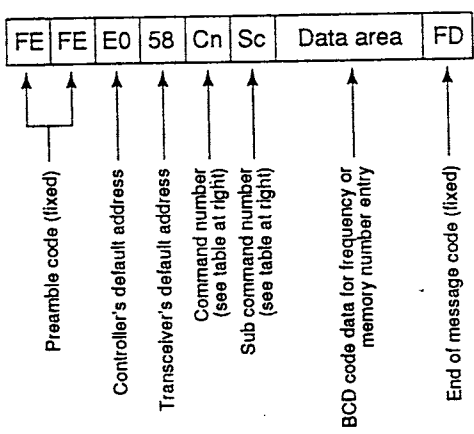

NG MESSAGE TO CONTROLLER

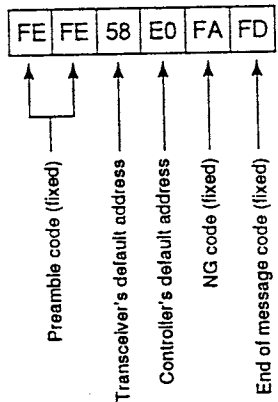

COMMAND TABLE

00	—	Send frequency data
01	xx	Send mode data
02	—	Read band edge frequencies
03	—	Read display frequency
04	—	Read display mode
05	—	Set frequency data
06	00* ¹	Set LSB
	01* ¹	Set USB
	02* ¹	Set AM
	03* ¹	Set CW
	04* ¹	Set RTTY
	05* ¹	Set FM
	06* ¹	Set WFM
07	—	Set to VFO
	00	Set to VFO A
	01	Set to VFO B
	A0	VFO A=B
	B0	Switch VFO A and B
08	—	Set to memory mode
	mc* ²	Mch
09	—	Memory write
0A	—	Memory to VFO
0B	—	Memory clear
0C	—	Read duplex offset frequency
0D	—	Set duplex offset frequency

*¹When wide or normal operation is available, add "00" for wide operation or "01" for normal operation; when normal or narrow operation is available, add "00" for normal operation or "01" for narrow operation; when wide, normal and narrow operation is available, add "00" for wide operation, "01" for normal operation and "02" for narrow operation.

*²Memory channel number 1A=0100/1b=0101, 2A=0102/2b=0103, 3A=0104/3b=0105, C1=0106, C2=0107.

0E	00	Scan stop
	01	Scan start
0F	00	Split OFF
	01	Split ON
	10	Simplex mode
	11	Duplex mode
	12	Duplex + mode
10	00	10 Hz TS
	01	100 Hz TS
	02	1 kHz TS
	03	5 kHz TS
	04	9 kHz TS
	05	10 kHz TS
	06	12.5 kHz TS
	07	20 kHz TS
	08	25 kHz TS
	09	100 kHz TS
11	xx	ATT ON/OFF; 00=OFF; 20=ON
15	01	Read squelch condition
	02	Read S-meter level
16	02	Preamp setting
	12	AGC setting
	22	NB setting
	42	TONE setting
	43	TSQL setting
	44	COMP setting
	46	VOX setting
47	BK-IN setting	
19	00	Read transceiver ID code

1/8
10x2

Remote jack (CI-V) information

CI-V connection example

The transceiver can be connected through an optional CT-17 CI-V LEVEL CONVERTER to a personal computer equipped with an RS-232C port. The Icom Communications Interface-V (CI-V) controls the following functions of the receiver.

Up to 4 Icom CI-V transceivers or receivers can be connected to a personal computer equipped with an RS-232C port. See p. 32 for setting the CI-V condition using set mode.

Data format

The CI-V system can be operated using the following data formats. Data formats differ according to command numbers. A data area or sub command is added for some commands.

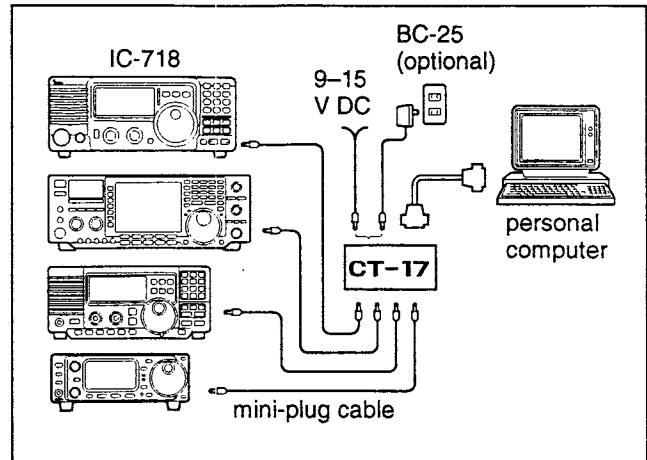

CONTROLLER TO IC-718

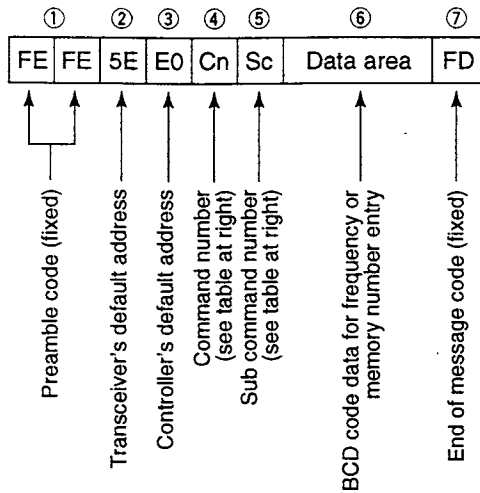

OK MESSAGE TO CONTROLLER

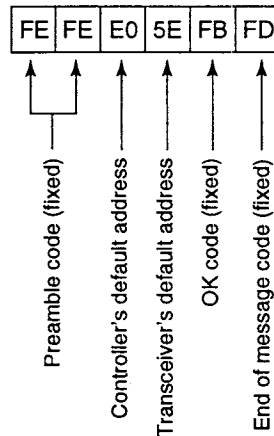

IC-718 TO CONTROLLER

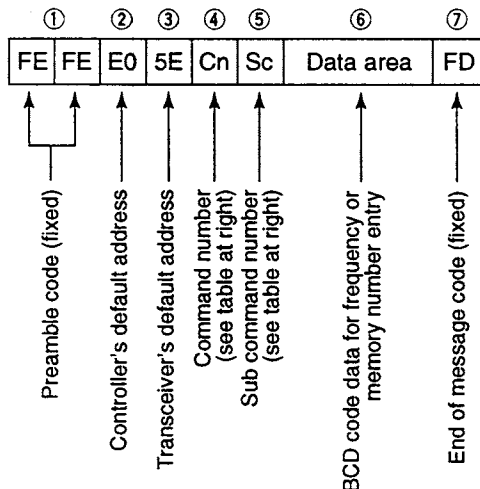

NG MESSAGE TO CONTROLLER

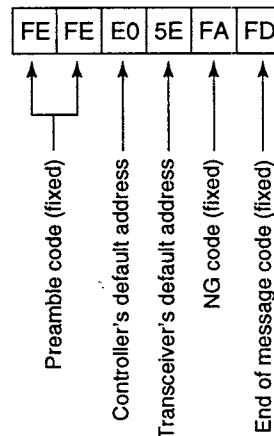

2 of 2

•Command table

Command	Sub command	Description
00	—	Send frequency data
01	—	Send mode data
02	—	Read Upper/Lower frequencies
03	—	Read frequencies
04	—	Read operating mode
05	—	Set operating frequency
06	—	Set mode
07	—	Set VFO
	00	Set VFO A
	01	Set VFO B
	A0	VFO A=B
	B0	VFO A ⇄ B
08	—	Set Memory
	—	Set Memory CH
09	—	Memory write
0A	—	Memory ⇄ VFO
0B	—	Memory clear
0E	00	Scan stop
	01	Prog/Memo Scan Start
	D0	Resume OFF
	D3	Resume ON
0F	00	SPLIT OFF
	01	SPLIT ON
10	—	Set TS
11	—	ATT
14	01	AF Gain
	02	RF Gain
	03	SQL Level
	06	NR Level
	09	CW Pitch
	0A	RF Power
	0B	MIC Gain
	0C	KEY Speed
	0F	BK-IN Delay
15	01	Read SQL Open/Close
	02	Read SIG (S-meter) level
16	02	PRE-AMP
	22	NB
	40	NR
	41	Auto Notch
	44	COMP
	46	VOX
	47	BK-IN
19	00	Read ID

12-9 Remote jack

■ CI-V CONNECTION EXAMPLE

The transceiver can be connected through an optional CW-17 CI-V LEVEL CONVERTER to a personal computer equipped with an RS-232C port. The Icom Communications Interface-V (CI-V) controls the following functions of the transceiver.

Up to 4 Icom CI-V transceivers or receivers can be connected to a personal computer equipped with an RS-232C port. See p. 64 for setting the CI-V condition using set mode.

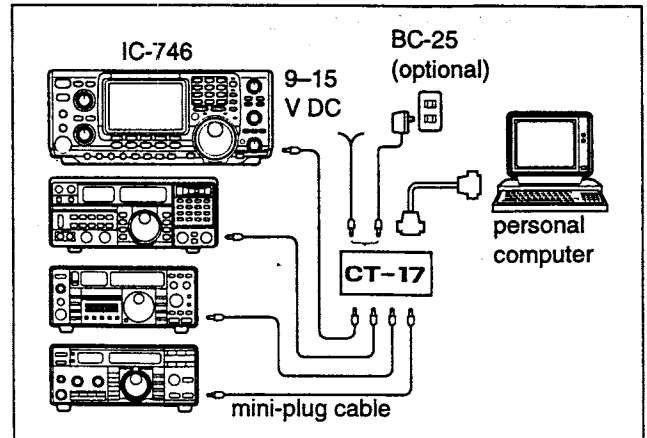

■ DATA FORMAT

The CI-V system can be operated using the following data formats. Data formats differ according to command numbers. A data area or sub command is added for some commands.

CONTROLLER TO IC-746

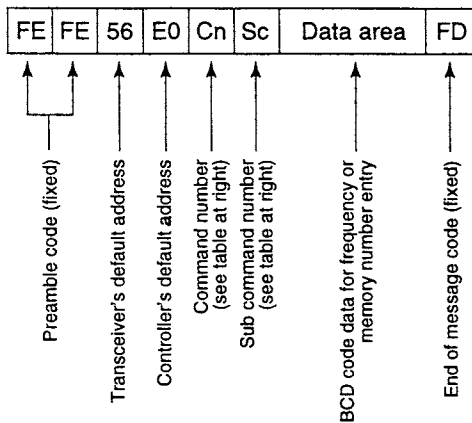

OK MESSAGE TO CONTROLLER

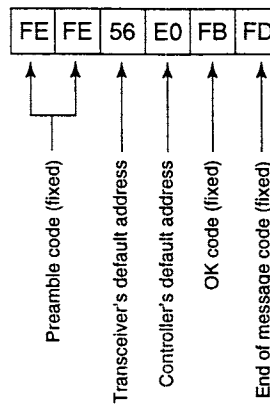

IC-746 TO CONTROLLER

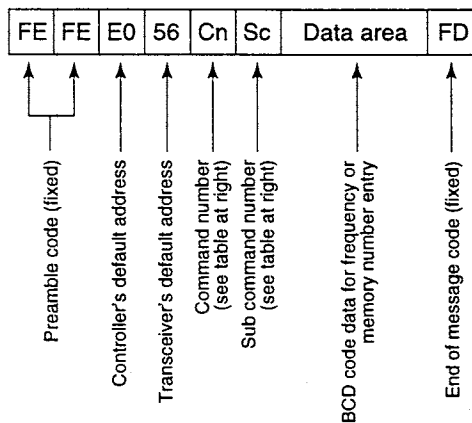

NG MESSAGE TO CONTROLLER

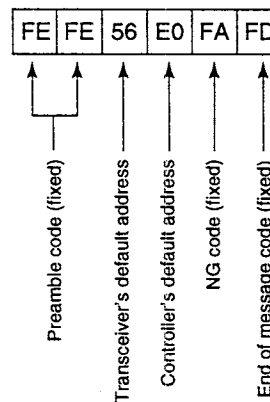

■ COMMAND TABLE

Cn	Sc	Description
00		Sets frequency (transceive)
01	xx	Sets mode (transceive)
02		Reads band edge frequency
03		Reads display frequency
04		Reads display mode
05		Sets frequency
06	00	Sets LSB mode
	01	Sets USB mode
	02	Sets AM mode
	03	Sets CW mode
	04	Sets RTTY mode
	05	Sets FM mode
	07	Sets CW-R mode
	08	Sets RTTY-R mode
07		Selects VFO operation
	00	Sets VFO A
	01	Sets VFO B
	A0	Sets VFO A=B
08	B0	Exchanges VFO A and B
		Select memory operation
	xx	Sets a M-CH (P1=0100/P2=0101/C=0102)
09		Writes to memory
0A		Transfers contents from memory to VFO
0B		Clears the memory channel
0C		Reads the duplex offset frequency
0D		Sets the duplex offset frequency
0E	00	Stops scan
	01	Starts program/memory scan
	02	Starts program scan
	03	Starts Δ F scan
	12	Starts fine program scan
	13	Starts fine Δ F scan
	22	Starts memory scan
	23	Starts select memory scan
	Ax	Sets the range for Δ F scan*1
	B0	Turns a "select" setting OFF
	B1	Turns a "select" setting ON
	D0	Turns scan resume OFF
D3	Turns scan resume ON	
0F	00	Turns split operation OFF
	01	Turns split operation ON
	10	Selects simplex operation
	11	Selects -duplex operation
	12	Selects +duplex operation

*17 spans are available (A1 to A7): ± 5 kHz, ± 10 kHz, ± 20 kHz, ± 50 kHz, ± 100 kHz, ± 500 kHz and ± 1 MHz.

*21 Hz when fine tuning is set.

*3When not writing data, reading is also possible.

*4Clear other channel counters before inputting a counter.

Cn	Sc	Description
10	00	Sets 10 Hz tuning step*2
	01	Sets 100 Hz tuning step
	02	Sets 1 kHz tuning step
	03	Sets 5 kHz tuning step
	04	Sets 9 kHz tuning step
	05	Sets 10 kHz tuning step
	06	Sets 12.5 kHz tuning step
	07	Sets 20 kHz tuning step
	08	Sets 25 kHz tuning step
11*3	xx	Toggles [ATT] ON/OFF (0=OFF, 20=ON)
12	01	Selects [ANT1] connector
	02	Selects [ANT2] connector
13	00	Sets UT-102 for S-level+freq.+mode
	01	Sets UT-102 for S-level+freq.
	02	Sets UT-102 for mode
14	01	Sets AF level (0 to 255)
	02	Sets RF gain (0=max. CCW; 255=11 o'clock)
	03	Sets squelch (0=11 o'clock CW; 255=max. CW)
	05	Sets APF level (0 to 255)
	06	Sets NR level (0 to 255)
	07	Sets [TWIN PBT] (inside) <small>0=narrows upper side 128=center</small>
	08	Sets [TWIN PBT] (outside) <small>255=narrows lower side</small>
	09	Sets the CW PITCH level (0 to 255)
	0A	Sets RF PWR (0 to 255)
	0B	Sets the MIC GAIN level (0 to 255)
	0C	Sets the KEY SPEED level (0 to 255)
15	01	Reads the squelch condition (open/closed)
	02	Reads the S-meter squelch level
16*3	02	Sets the pre-amp (0=OFF, 1=P.AMP1, 2=P.AMP2)
	12	Sets the AGC (0=OFF, 1=AGC-F, 2=AGC-S)
	22	Sets the NB (0=OFF, 1=ON)
	32	Sets the APF (0=OFF, 1=ON)
	40	Sets the NR (0=OFF, 1=ON)
	41	Sets the ANF (0=OFF, 1=ON)
	42	Sets the TONE (0=OFF, 1=ON)
	43	Sets the TSQL (0=OFF, 1=ON)
	44	Sets the COMP (0=OFF, 1=ON)
	45	Sets the MONITOR (0=OFF, 1=ON)
46	Sets the VOX (0=OFF, 1=ON)	
47	Sets the BK-IN (0=OFF, 1=semi BK-IN, 2=fullBK-IN)	
19	00	Reads the transceiver's ID code
1A*3	00	Sets memory channel contents
	01	Sets bandstacking register contents
	02	Sets memory keyer contents*4
	03	Reads the IF filter setting
1B	00	Sets the tone frequency for repeater use
	01	Sets the tone frequency for tone squelch
1C	00	Exchanges transmit and receive (0=Rx, 1=Tx)

746p R0
1 of 5

Remote jack (CI-V) information

CI-V connection example

The transceiver can be connected through an optional CT-17 CI-V LEVEL CONVERTER to a personal computer equipped with an RS-232C port. The Icom Communications Interface-V (CI-V) controls the following functions of the transceiver.

Up to 4 Icom CI-V transceivers or transceivers can be connected to a personal computer equipped with an RS-232C port. See p. 88 for setting the CI-V condition using set mode.

Data format

The CI-V system can be operated using the following data formats. Data formats differ according to command numbers. A data area or sub command is added for some commands.

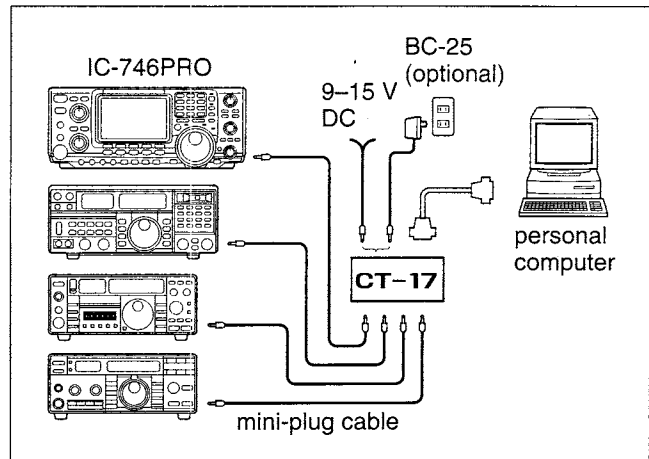

Controller to IC-746PRO

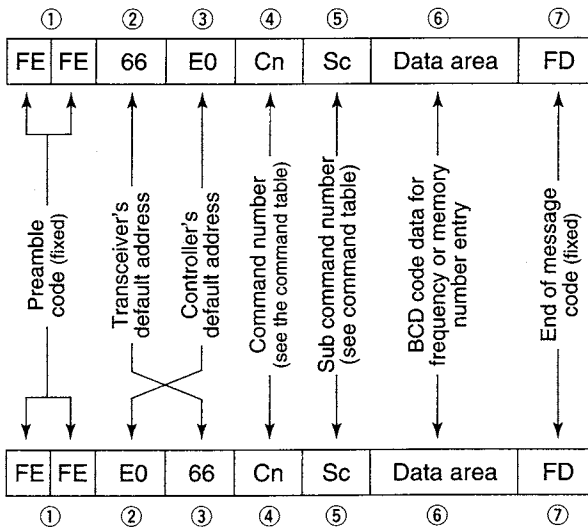

IC-746PRO to controller

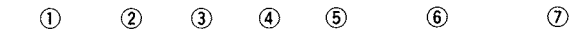

OK message to controller

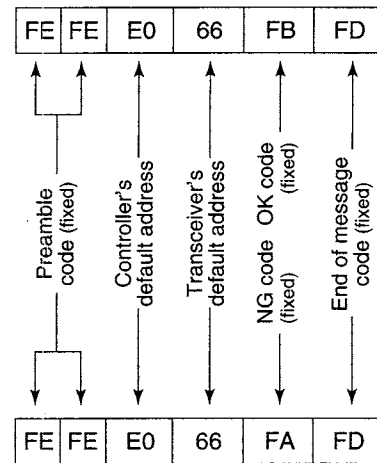

NG message to controller

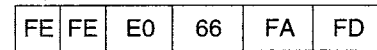

Command table

Command	Sub command	Description
00	—	Send frequency data
01	Same as command 06	Send mode data
02	—	Read band edge frequencies
03	—	Read operating frequency
04	—	Read operating mode
05	—	Set operating frequency
06	00	Select LSB
	01	Select USB
	02	Select AM
	03	Select CW
	04	Select RTTY
	05	Select FM
	07	Select CW-R
	08	Select RTTY-R
07	—	Select VFO mode
	00	Select VFO A
	01	Select VFO B
	A0	Equalize VFO A and VFO B

Command	Sub command	Description
07	B0	Exchange VFO A and VFO B
08	—	Select memory mode
	0001-0101*	Select memory channel *P1=0100, P2=0101
	0102	Select the call channel
09	—	Memory write
0A	—	Memory to VFO
0B	—	Memory clear
0C	—	Read offset frequency
0D	—	Set offset frequency
0E	00	Scan stop
	01	Programmed/memory scan start
	02	Programmed scan start
	03	Δ F scan start
	12	Fine programmed scan start
	13	Fine Δ F scan start
	22	Memory scan start
	23	Select memory scan start

20F5

• Command table (continued)

Command	Sub command	Description
0E	A1-A7	Set ΔF scan span (A1=±5 kHz, A2=±10 kHz, A3=±20 kHz, A4=±50 kHz, A5=±100 kHz, A6=±500 kHz, A7=±1 MHz)
	B0	Set as non-select channel
	B1	Set as select channel
	D0	Set scan resume OFF
	D3	Set scan resume ON
0F	00	Turn the split function OFF
	01	Turn the split function ON
	10	Select simplex operation
	11	Select -DUP operation
	12	Select +DUP operation
10	00	Select 10 Hz (1 Hz) tuning step
	01	Select 100 Hz tuning step
	02	Select 1 kHz tuning step
	03	Select 5 kHz tuning step
	04	Select 9 kHz tuning step
	05	Select 10 kHz tuning step
	06	Select 12.5 kHz tuning step
	07	Select 20 kHz tuning step
	08	Select 25 kHz tuning step
11	—	Select/read attenuator (0=OFF, 1=ON)
12	—	Select/read antenna selection (0=ANT1, 1=ANT2)
13	00	Announce with voice synthesizer
	01	(00=all data; 01=frequency and S-meter level; 02=receive mode)
	02	
14	01 + Level data	[AF] level setting (0=max. CCW to 255=max. CW)
	02 + Level data	[RF] level setting (0=max. CCW to 255=11 o'clock)
	03 + Level data	[SQL] level setting (0=11 o'clock to 255=max. CW)
	06 + Level data	[NR] level setting (0=min. to 255=max.)
	07 + Level data	Inside [TWIN PBT] setting or IF shift setting (0=max. CCW, 128=center, 255=max. CW)
	08 + Level data	Outside [TWIN PBT] setting (0=max. CCW, 128=center, 255=max. CW)
	09 + Level data	[CW PITCH] setting (0=300 Hz, 128=600 Hz, 255=900 Hz)
	0A + Level data	[RF PWR] setting (0=mini. to 255=max.)
	0B + Level data	[MIC GAIN] setting (0=mini. to 255=max.)
	0C + Level data	[KEY SPEED] setting (0=slow to 255=fast)
	0D + Level data	[NOTCH] setting (0=low freq. to 255=high freq.)
0E + Level data	COMP Level Delay setting (0=0 to 10=10)	
0F + Level data	Break-IN DELAY setting (20=2.0d to 130=13.0d)	
15	01	Read squelch condition
	02	Read S-meter level
	11	Read RF power meter
	12	Read SWR meter
	13	Read ALC meter
16	02	Preamp (0=OFF; 1=preamp 1; 2=preamp 2)

Command	Sub command	Description
16	12	AGC selection (0=OFF; 1=Slow; 2=Mid; 3=Fast)
	22	Noise blanker (0=OFF; 1=ON)
	40	Noise reduction (0=OFF; 1=ON)
	41	Auto notch (0=OFF; 1=ON)
	42	Repeater tone (0=OFF; 1=ON)
	43	Tone squelch (0=OFF; 1=ON)
	44	Speech compressor (0=OFF; 1=ON)
	45	Monitor (0=OFF; 1=ON)
	46	VOX function (0=OFF; 1=ON)
	47	Break-in (0=OFF; 1=semi break-in; 2=full break-in)
	48	Manual notch (0=OFF; 1=ON)
	49	RTTY filter (0=OFF; 1=ON)
	4B	DTCS (0=OFF; 1=ON)
	4C	VSC (0=OFF; 1=ON)
19	00	Read the transceiver ID
1A	00	Send/read memory contents (see p. 97 for details)
	01	Send/read band stacking register contents (see p. 97 for details)
	02	Send/read memory keyer contents (see p. 97 for details)
	03	Send/read the selected filter width (0=50 Hz to 40/31=3600/2700 Hz)
	04	Send/read the selected AGC time constant (0=OFF, 1=0.1/0.3 sec. to 13=6.0/8.0 sec.)
	0501	Send/read LCD contrast (0=0% to 255=100%)
	0502	Send/read LCD backlight (0=0% to 255=100%)
	0503	Send/read beep gain (0=min. to 255=max.)
	0504	Send/read beep gain limit (0=OFF, 1=ON)
	0505	Send/read calibration marker (0=OFF, 1=ON)
	0506	Send/read confirmation beep (0=OFF, 1=ON)
	0507	Send/read band edge beep (0=OFF, 1=ON)
	0508	Send/read RF/SQL control set (0=Auto, 1=SQL, 2=RF+SQL)
	0509	Send/read meter peak hold set (0=OFF, 1=ON)
	0510	Send/read COMP meter set (0=OFF, 1=ON)
	0511	Send/read quick split set (0=OFF, 1=ON)
0512	Send/read split offset -9.999 to +9.999 MHz (see p. 98 for details)	
0513	Send/read split lock set (0=OFF, 1=ON)	
0514	Send/read duplex offset 0.000 to 9.999 MHz for HF (see p. 98 for details)	
0515	Send/read duplex offset 0.000 to 9.999 MHz for 50 MHz band (see p. 98 for details)	
0516	Send/read duplex offset 0.000 to 9.999 MHz for 144 MHz band (see p. 98 for details)	

305

•Command table (continued)

Command	Sub command	Description
1A	0517	Send/read one touch repeater set (0=DUP-, 1=DUP+)
	0518	Send/read auto repeater set (0=OFF, 1=ON-1, 2=ON-2)
	0519	Send/read tuner auto start set (0=OFF, 1=ON)
	0520	Send/read PTT tune set (0=OFF, 1=ON)
	0521	Send/read 9600 bps mode set (0=OFF, 1=ON)
	0522	Send/read antenna selection (0=OFF, 1=Manual, 2=Auto)
	0523	Send/read speech language (0=English, 1=Japanese)
	0524	Send/read speech speed (0=Slow, 1=Fast)
	0525	Send/read S-level speech (0=OFF, 1=ON)
	0526	Send/read memo pad numbers (0=5 ch, 1=10 ch)
	0527	Send/read main dial auto TS (0=OFF, 1=Low, 2=High)
	0528	Send/read mic. up/down speed (0=Low, 1=High)
	0529	Send/read quick RIT/ Δ TX clear function (0=OFF, 1=ON)
	0530	Send/read PBT shifting value popup set (0=OFF, 1=ON)
	0531	Send/read IF filter width popup set (0=OFF, 1=ON)
	0532	Send/read SSB/CW synchronous tuning function (0=OFF, 1=ON)
	0533	Send/read CW normal side set (0=LSB, 1=USB)
	0534	Send/read keyer 1st menu set (0=Keyer-root, 1=Keyer-send)
	0535	Send/read external keypad set (0=OFF, 1=Keyer send)
	0536	Send/read CI-V transceive set (0=OFF, 1=ON)
	0537	Send/read CI-V 731 mode set (0=OFF, 1=ON)
	0538	Send/read speech compressor level set (0=0 to 10=10)
	0539	Send/read SSB TX Tone (Bass) level (0=-5 to 10=+5)
	0540	Send/read SSB TX Tone (Treble) level (0=-5 to 10=+5)
	0541	Send/read SSB RX Tone (Bass) level (0=-5 to 10=+5)
	0542	Send/read SSB RX Tone (Treble) level (0=-5 to 10=+5)
	0543	Send/read AM TX Tone (Bass) level (0=-5 to 10=+5)
	0544	Send/read AM TX Tone (Treble) level (0=-5 to 10=+5)
	0545	Send/read AM RX Tone (Bass) level (0=-5 to 10=+5)
	0546	Send/read AM RX Tone (Treble) level (0=-5 to 10=+5)
0547	Send/read FM TX Tone (Bass) level (0=-5 to 10=+5)	

Command	Sub command	Description
1A	0548	Send/read FM TX Tone (Treble) level (0=-5 to 10=+5)
	0549	Send/read FM RX Tone (Bass) level (0=-5 to 10=+5)
	0550	Send/read FM RX Tone (Treble) level (0=-5 to 10=+5)
	0551	Send/read contact number style (0=Normal, 1=190 \rightarrow ANO, 2=190 \rightarrow ANT, 3=90 \rightarrow NO, 4=90 \rightarrow NT)
	0552	Send/read count up trigger channel (1=M1, 2=M2, 3=M3, 4=M4)
	0553	Send/read present number (1-9999)
	0554	Send/read CW side tone gain (0=min. to 255=max.)
	0555	Send/read CW side tone gain limit (0=OFF, 1=ON)
	0556	Send/read CW keyer repeat time (1=1 sec. to 60=60 sec.)
	0557	Send/read CW keyer dot/dash ratio (28=1:1:2.8 to 45=1:1:4.5)
	0558	Send/read rise time (0=2 msec., 1=4 msec., 2=6 msec., 3=8 msec.)
	0559	Send/read paddle polarity (0=Normal, 1=Reverse)
	0560	Send/read keyer type (0=Straight, 1=Bug-key, 2=ELEC-Key)
	0561	Send/read mic. up/down keyer set (0=OFF, 1=ON)
	0562	Send/read RTTY filter bandwidth (0=250 Hz, 1=300 Hz, 2=350 Hz, 3=500 Hz, 4=1 kHz)
	0563	Send/read twin peak filter (0=OFF, 1=ON)
	0564	Send/read RTTY mark frequency (0=1275 Hz, 1=1615 Hz, 2=2125 Hz)
	0565	Send/read RTTY shift width (0=170 Hz, 1=200 Hz, 2=425 Hz)
	0566	Send/read RTTY keying polarity (0=Normal, 1=Reverse)
	0567	Send/read RTTY decode USOS (0=OFF, 1=ON)
	0568	Send/read RTTY decode new line code (0=CR,LF,CR+LF, 1=CR+LF)
	0569	Send/read number of RTTY decoder line (0=2 lines, 1=3 lines)
	0570	Send/read scan speed (0=Low, 1=High)
	0571	Send/read scan resume (0=OFF, 1=ON)
	0572	Send/read NB level (0=0% to 255=100%)
	0573	Send/read VOX gain (0=0% to 255=100%)
	0574	Send/read anti VOX gain (0=0% to 255=100%)
	0575	Send/read VOX delay (0=0.0 sec. to 20=2.0 sec.)
	0576	Send/read Break-IN delay set (20=2.0d to 130=13.0d)

• Command table (continued)

Command	Sub command	Description
1A	0577	Send/read MONITOR level (0=0% to 255=100%)
	06	Send/read DATA mode (0=OFF, 1=ON)
	07	Send/read SSB transmit bandwidth (0=WIDE, 1=MID, 2=NAR)
	08	Send/read DSP filter shape (0= sharp, 1= soft)
1B	00	Set/read repeater tone frequency (see p. 98 for details)
	01	Set/read TSQL tone frequency (see p. 98 for details)
	02	Set/read DTCS code and polarity (see p. 98 for details)
1C	00	Set/read the transceiver's condition (0=Rx; 1=Tx)
	01	Set/read antenna tuner condition (0=OFF, 1=ON, 2=Start tuning or while tuning)

◇ To send/read memory contents

When sending or reading memory contents, additional code as follows must be added to appoint the memory channel.

➔ Additional code: 0000–0102 (0100=P1, 0101=P2, 0102=Call)

◇ Band stacking register

To send or read the desired band stacking register's contents, combined code of the frequency band and register codes as follows are used.

For example, when sending/reading the oldest contents in the 21 MHz band, the code "0703" is used.

• Frequency band code

Code	Frequency band	Frequency range (unit: MHz)
01	1.8	1.800000– 1.999999
02	3.5	3.400000– 4.099999
03	7	6.900000– 7.499999
04	10	9.900000–10.499999
05	14	13.900000–14.499999
06	18	17.900000–18.499999
07	21	20.900000–21.499999
08	24	24.400000–25.099999
09	28	28.000000–29.999999
10	50	50.000000–54.000000
11	144	144.000000–148.000000
12	GENE	Other than above

• Register code

Code	Registered number
01	1 (latest)
02	2
03	3 (oldest)

◇ Codes for memory keyer contents

To send or read the desired memory keyer contents, the channel and character codes as follows are used.

• Channel code

Code	Channel number
01	M1
02	M2
03	M3
04	M4

• Character's code

Character	ASCII code	Description
0–9	30–39	Numerals
A–Z	41–5A	Alphabetical characters
space	20	Word space
/	2F	Symbol
?	3F	Symbol
,	2C	Symbol
.	2E	Symbol
^	5E	e.g., to send \bar{B} , enter ^4254
*	2A	Inserts contact number (can be used for 1 channel only)

◇ Codes for memory name contents

To send or read the desired memory name settings, the character codes, instructed codes for memory keyer contents as above, and follows are additionally used.

• Character's code— Alphabetical characters

Character	ASCII code	Character	ASCII code
a–z	61–7A	—	—

• Character's code— Symbols

Character	ASCII code	Character	ASCII code
!	21	#	23
\$	24	%	25
&	26	¥	5C
?	3F	"	22
'	27	`	60
+	2B	-	2D
:	3A	;	3B
=	3D	<	3C
>	3E	(28
)	29	[5B
]	5D	{	7B
}	7D		7C
_	5F	-	7E

◆ **Split/Duplex frequency setting**

The following data sequence is used when sending/reading the split or duplex frequency setting.

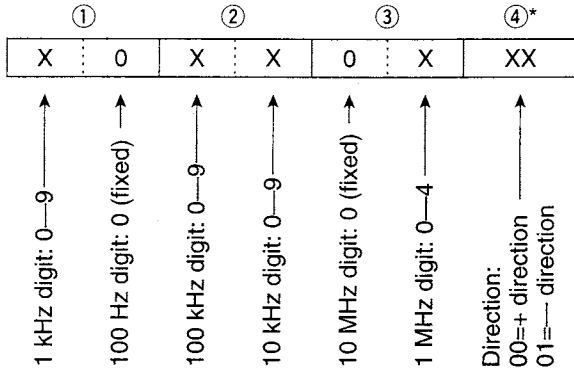

*No need to enter for duplex frequency setting.

◆ **Repeater tone/tone squelch frequency setting**

The following data sequence is used when sending/reading the DTCS code and polarity setting.

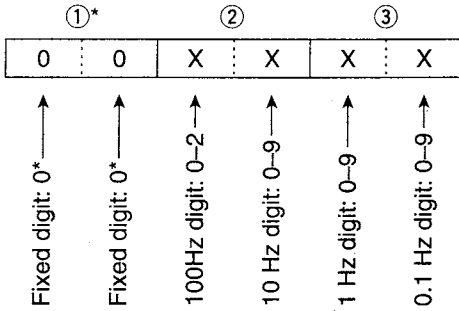

*Not necessary when setting a frequency.

◆ **DTCS code and polarity setting**

The following data sequence is used when sending/reading the DTCS code and polarity setting.

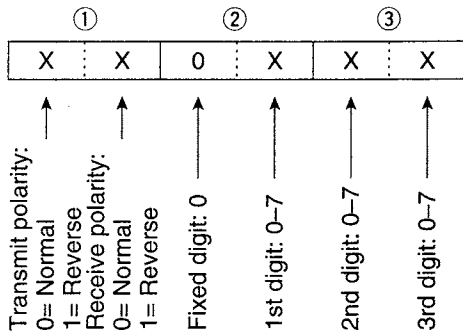

IC 756

Remote jack (CI-V) information

CI-V connection example

The transceiver can be connected through an optional CT-17 CI-V LEVEL CONVERTER to a personal computer equipped with an RS-232C port. The Icom Communication Interface-V (CI-V) controls the following functions of the transceiver.

Up to four Icom CI-V transceivers or receivers can be connected to a personal computer equipped with an RS-232C port. See p. 60 for setting the CI-V condition using set mode.

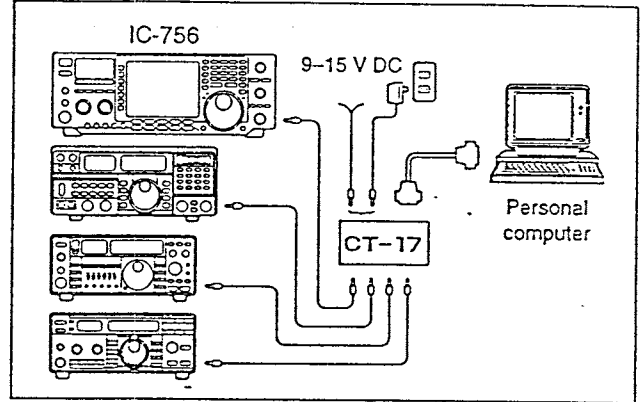

Data format

The CI-V system can be operated using the following data formats. Data formats differ according to command numbers. A data area or sub command is added for some commands.

CONTROLLER TO IC-756

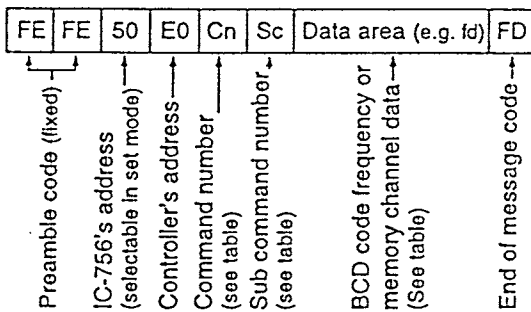

IC-756 TO CONTROLLER

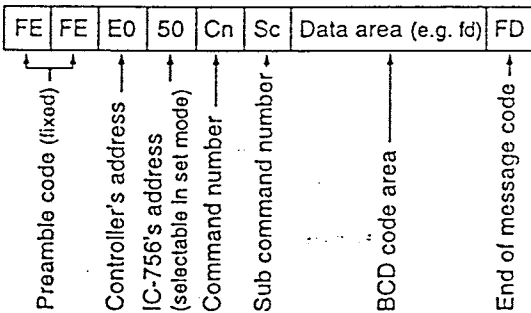

OK or NG MESSAGE TO CONTROLLER

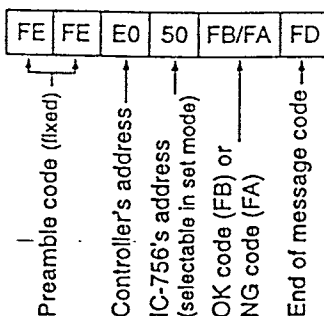

Command table

Description	Command	Sub command
Frequency setting	05	Data* ¹
Operating mode	06	00
		01
		02
		03
		04
		05
VFO mode selection MAIN → SUB MAIN = SUB Dualwatch OFF Dualwatch ON Main readout selection Sub readout selection	07	—
		B0
		B1
		C0
		C1
		D0
Memory mode selection Memory channel selection	08	—
		Mch no. (BCD)* ²
Memory write	09	—
Memory transfer to VFO	0A	—
Memory clear	0B	—
Scan stop Start programmed/memory scan Start programmed scan Start ΔF scan Start fine programmed scan Start fine ΔF scan Start memory scan Start select memory scan	0E	00
		01
		02
		03
		12
		13
		22
		23
Split OFF Split ON	0F	00
		01
[TS] OFF (10 or 1 Hz step) [TS] ON (1 kHz step) [TS] ON (5 kHz step) [TS] ON (9 kHz step) [TS] ON (10 kHz step)	10	00
		01
		02
		03
		04
[ANT1] selection [ANT2] selection [ANT1/RX] selection [ANT2/RX] selection	12	00 or 0000
		01 or 0100
		0001
		0101

*1 Frequency data arrangement (BCD code)
10 Hz, 1 Hz, 1 kHz, 100 Hz, 100 kHz, 10 kHz,
10 MHz, 1 MHz, 1 GHz then 100 MHz

*2 Scan edge channel P1=0100, P2=0101

20E2

06	03	Set CW
	04	Set RTTY
	05	Set FM
	07	Set CW-R
	08	Set RTTY-R
07	—	Select VFO mode
	B0	Exchange main and sub readouts
	B1	Equalize main and sub readouts
	C0	Turn the dualwatch OFF
	C1	Turn the dualwatch ON
	D0	Select main readout
08	—	Select memory mode
	0001 - 0101*1	Select memory channel *P1=0100, P2=0101
09	—	Memory write
0A	—	Memory to VFO
0B	—	Memory clear
0E	00	Scan stop
	01	Programmed/memory scan start
	02	Programmed scan start
	03	Δ F scan start
	12	Fine programmed scan start
	13	Fine Δ F scan start
	22	Memory scan start
	23	Select memory scan start
	A1 - A7	Set Δ F scan span (5 kHz, A2= \pm 10 kHz, A3= \pm 20 kHz, A4= \pm 50 kHz, A5= \pm 100 kHz, A6= \pm 500 kHz, A7= \pm 1 MHz)
	B0	Set as non-select channel
	B1	Set as select channel
D0	Set scan resume OFF	
D3	Set scan resume ON	
0F	00	Turn the split function OFF
	01	Turn the split function ON
10	00	10 Hz (1 Hz) tuning step
	01	100 Hz tuning step
	02	1 kHz tuning step
	03	5 kHz tuning step
	04	9 kHz tuning step
	05	10 kHz tuning step
	06	12.5 kHz tuning step
	07	20 kHz tuning step
	08	25 kHz tuning step
11	00	Attenuator OFF
	06	Attenuator ON (6 dB)
	12	Attenuator ON (12 dB)
	18	Attenuator ON (18 dB)
12	00	Select [ANT1]
	01	Select [ANT2] (Add 0 or 1 to turn [RX ANT] OFF or ON, respectively.)
13	00	Announce with voice synthesizer
	01	(00=all data; 01=frequency and S-meter level; 02=receive mode)
	02	

14	08 + level data	128=center, 255=max. CW) Outside [TWIN PBT] setting (0=max. CCW, 128=center, 255=max. CW)
	09 + level data	[CW PITCH] setting (0=low pitch to 255=high pitch)
	0A + level data	[RF POWER] setting (0=min. to 255=max.)
	0B + level data	[MIC GAIN] setting (0=min. to 255=max.)
	0C + level data	[KEY SPEED] setting (0=slow to 255=fast)
	0D + level data	[NOTCH] setting (0=low freq. to 255=high freq.)
	0E + level data	[COMP] setting (0=min. to 255=max.)
	0F + level data	[BK-IN DELAY] setting (0=short delay to 255=long delay)
	10 + level data	[BAL] setting (0=max. CCW, 128=center, 255=max. CW)
	15	01
02		Read S-meter level
16	02	Set preamp (0=OFF; 1=preamp 1; 2=preamp 2)
	12	Set AGC time constant (1=FAST; 2=MID; 3=SLOW)
	22	Set noise blanker (0=OFF; 1=ON)
	40	Set noise reduction (0=OFF; 1=ON)
	41	Set auto notch (0=OFF; 1=ON)
	42	Set repeater tone (0=OFF; 1=ON)
	43	Set tone squelch (0=OFF; 1=ON)
	44	Set speech compressor (0=OFF; 1=ON)
	45	Set monitor (0=OFF; 1=ON)
	46	Set VOX function (0=OFF; 1=ON)
47	Set break-in (0=OFF; 1=ON)	
48	Set manual notch (0=OFF; 1=ON)	
49	Set RTTY filter notch (0=OFF; 1=ON)	
19	00	Read the transceiver ID
1A	00	Send/read memory contents
	01	Send/read band stacking register contents
1B	02	Send/read CW keyer contents
	00	Set repeater tone frequency
1C	01	Set tone squelch tone frequency
	00	Set the transceiver to receive or transmit condition (0=Rx; 1=Tx)

756 PRO II
10FY

Remote jack (CI-V) information

•CI-V connection example

The transceiver can be connected through an optional CT-17 CI-V LEVEL CONVERTER to a personal computer equipped with an RS-232C port. The Icom Communications Interface-V (CI-V) controls the following functions of the transceiver.

Up to 4 Icom CI-V transceivers or transceivers can be connected to a personal computer equipped with an RS-232C port. See p. 73 for setting the CI-V condition using set mode.

•Data format

The CI-V system can be operated using the following data formats. Data formats differ according to command numbers. A data area or sub command is added for some commands.

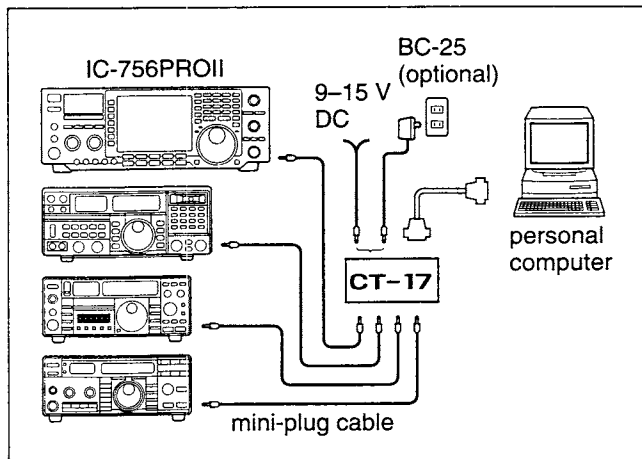

Controller to IC-756PROII

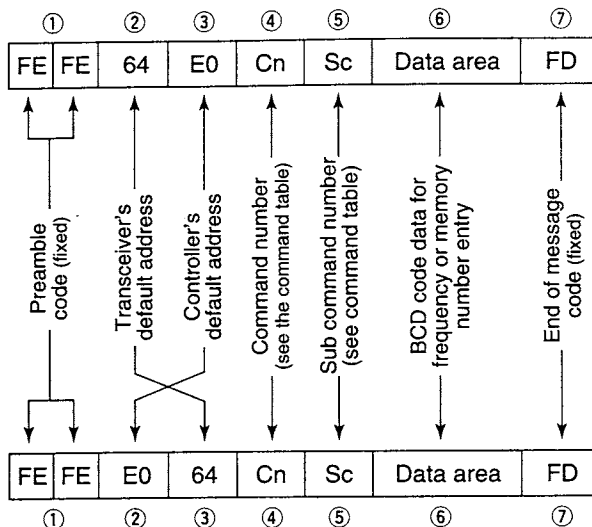

IC-756PROII to controller

OK message to controller

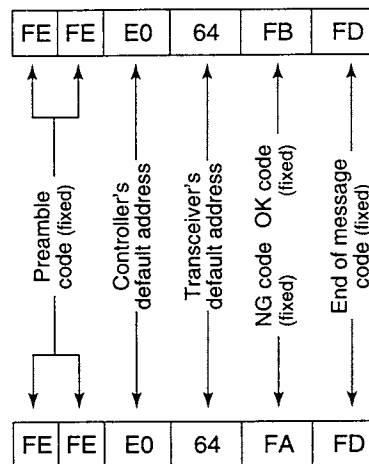

NG message to controller

•Command table

Command	Sub command	Description
00	—	Send frequency data
01	Same as command 06	Send mode data
02	—	Read band edge frequencies
03	—	Read operating frequency
04	—	Read operating mode
05	—	Set frequency data
06	00	Select LSB
	01	Select USB
	02	Select AM
	03	Select CW
	04	Select RTTY
	05	Select FM
	07	Select CW-R
	08	Select RTTY-R
07	—	Select VFO mode
	B0	Exchange main and sub readouts
	B1	Equalize main and sub readouts
	C0	Turn the dualwatch OFF

Command	Sub command	Description
07	C1	Turn the dualwatch ON
	D0	Select main readout
	D1	Select sub readout
08	—	Select memory mode
	0001-0101**	Select memory channel **P1=0100, P2=0101
09	—	Memory write
0A	—	Memory to VFO
0B	—	Memory clear
0E	00	Scan stop
	01	Programmed/memory scan start
	02	Programmed scan start
	03	ΔF scan start
	12	Fine programmed scan start
	13	Fine ΔF scan start
	22	Memory scan start
23	Select memory scan start	

2074

• **To send/read memory contents**

When sending or reading memory contents, additional code as follows must be added to appoint the memory channel.

➔ Additional code: 0000-0101 (0100=P1, 0101=P2)

• **Band stacking register**

To send or read the desired band stacking register's contents, combined code of the frequency band and register codes as follows are used.

For example, when sending/reading the oldest contents in the 21 MHz band, the code "0703" is used.

• **Frequency band code**

Code	Frequency band	Frequency range (unit: MHz)
01	1.8	1.800000- 1.999999
02	3.5	3.400000- 4.099999
03	7	6.900000- 7.499999
04	10	9.900000-10.499999
05	14	13.900000-14.499999
06	18	17.900000-18.499999
07	21	20.900000-21.499999
08	24	24.400000-25.099999
09	28	28.000000-29.999999
10	50	50.000000-54.000000
11	GENE	Other than above

• **Register code**

Code	Registered number
01	1 (latest)
02	2
03	3 (oldest)

• **Channel code for memory keyer**

To send or read the desired memory keyer contents, the channel and character codes as follows are used.

• **Channel code**

Code	Channel number
01	M1
02	M2
03	M3
04	M4

• **Character's code**

Character	ASCII code	Description
-----------	------------	-------------

• **Character's code for my call**

Character	ASCII code	Description
0-9	30-39	Numerals
A-Z	41-5A	Alphabetical characters
a-z	61-7A	Alphabetical characters
space	20	Word space
-	2D	Symbol
.	2E	Symbol
/	2F	Symbol

• **FM split frequency (HF/50 MHz) setting**

The following data sequence is used when sending/reading the FM split frequency setting.

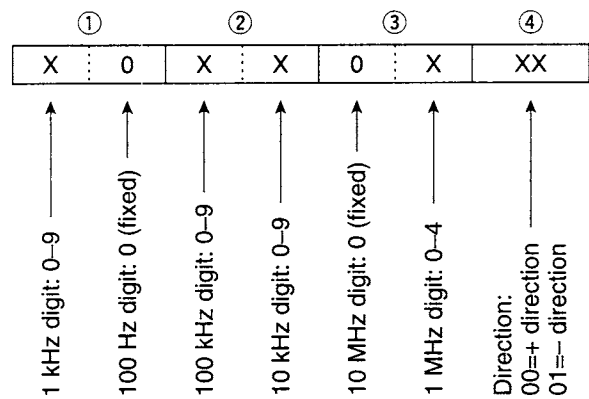

3064

•Command table (continued)

Command	Sub command	Description
0E	A1-A7	Set ΔF scan span (A1= ± 5 kHz, A2= ± 10 kHz, A3= ± 20 kHz, A4= ± 50 kHz, A5= ± 100 kHz, A6= ± 500 kHz, A7= ± 1 MHz)
	B0	Set as non-select channel
	B1	Set as select channel
	D0	Set scan resume OFF
	D3	Set scan resume ON
0F	00	Turn the split function OFF
	01	Turn the split function ON
10	00	Select 10 Hz (1 Hz) tuning step
	01	Select 100 Hz tuning step
	02	Select 1 kHz tuning step
	03	Select 5 kHz tuning step
	04	Select 9 kHz tuning step
	05	Select 10 kHz tuning step
	06	Select 12.5 kHz tuning step
	07	Select 20 kHz tuning step
	08	Select 25 kHz tuning step
11	00	Attenuator OFF
	06	Attenuator ON (6 dB)
	12	Attenuator ON (12 dB)
	18	Attenuator ON (18 dB)
12	00	Select/read antenna selection (00=ANT1, 01=ANT2 : Add 0 or 1 to turn [RX ANT] OFF or ON, respectively.)
	01	
13	00	Announce with voice synthesizer (00=all data; 01=frequency and S-meter level; 02=receive mode)
	01	
	02	
14	01 + Level data	[AF] level setting (0=max. CCW to 255=max. CW)
	02 + Level data	[RF] level setting (0=max. CCW to 255=11 o'clock)
	03 + Level data	[SQL] level setting (0=11 o'clock to 255=max. CW)
	06 + Level data	[NR] level setting (0=min. to 255=max.)
	07 + Level data	Inside [TWIN PBT] setting or IF shift setting (0=max. CCW, 128=center, 255=max. CW)
	08 + Level data	Outside [TWIN PBT] setting (0=max. CCW, 128=center, 255=max. CW)
	09 + Level data	[CW PITCH] setting (0=low pitch to 255=high pitch)
	0A + Level data	[RF POWER] setting (0=min. to 255=max.)

Command	Sub command	Description
16	02	Preamp (0=OFF; 1=preamp 1; 2=preamp 2)
	12	AGC selection (1=Fast; 2=Mid; 3=Slow)
	22	Noise blanker (0=OFF; 1=ON)
	40	Noise reduction (0=OFF; 1=ON)
	41	Auto notch (0=OFF; 1=ON)
	42	Repeater tone (0=OFF; 1=ON)
	43	Tone squelch (0=OFF; 1=ON)
	44	Speech compressor (0=OFF; 1=ON)
	45	Monitor (0=OFF; 1=ON)
	46	VOX function (0=OFF; 1=ON)
	47	Break-in (0=OFF; 1=semi break-in; 2=full break-in)
	48	Manual notch (0=OFF; 1=ON)
	49	RTTY filter (0=OFF; 1=ON)
	19	00
1A	00	Send/read memory contents (see p. 82 for details)
	01	Send/read band stacking register contents (see p. 82 for details)
	02	Send/read memory keyer contents (see p. 82 for details)
	03	Send/read the selected filter width (0=50 Hz to 40/31=3600/2700 Hz)
	04	Send/read the selected AGC time constant (0=OFF, 1=0.1/0.3 sec. to 13=6.0/8.0 sec.)
	0501	Send/read SSB TX Tone (Bass) level (0=min. to 10=max.)
	0502	Send/read SSB TX Tone (Treble) level (0=min. to 10=max.)
	0503	Send/read MONITOR gain (0=min. to 255=max.)
	0504	Send/read CW side tone gain (0=min. to 255=max.)
	0505	Send/read CW side tone gain limit (0=OFF, 1=ON)
0506	Send/read beep gain (0=min. to 255=max.)	
0507	Send/read beep gain limit (0=OFF, 1=ON)	
0508	Send/read LCD contrast (0=0% to 255=100%)	
0509	Send/read LCD backlight (0=0% to 255=100%)	

•Command table (continued)

Command	Sub command	Description
1A	0518	Send/read power-OFF period (5=5 min. to 120=120 min. in 5 min. step)
	0519	Send/read calibration marker (0=OFF, 1=ON)
	0520	Send/read confirmation beep (0=OFF, 1=ON)
	0521	Send/read band edge beep (0=OFF, 1=ON)
	0522	Send/read RF/SQL control set (0=Auto, 1=SQL, 2=RF+SQL)
	0523	Send/read quick dualwatch set (0=OFF, 1=ON)
	0524	Send/read quick split set (0=OFF, 1=ON)
	0525	Send/read FM split offset (HF) -4.000 to +4.000 MHz (see p. 82 for details)
	0526	Send/read FM split offset (50 MHz) -4.000 to +4.000 MHz (see p. 82 for details)
	0527	Send/read split lock set (0=OFF, 1=ON)
	0528	Send/read tuner auto start set (0=OFF, 1=ON)
	0529	Send/read PTT tune set (0=OFF, 1=ON)
	0530	Send/read antenna selection (0=OFF, 1=Manual, 2=Auto)
	0531	Send/read RTTY mark frequency (0=1275 Hz, 1=1615 Hz, 2=2125 Hz)
	0532	Send/read RTTY shift width (0=170 Hz, 1=200 Hz, 2=425 Hz)
	0533	Send/read RTTY keying polarity (0=Normal, 1=Reverse)
	0534	Send/read RTTY decode USOS (0=OFF, 1=ON)
	0535	Send/read RTTY decode new line code (0=CR,LF,CR+LF, 1=CR+LF)
	0536	Send/read speech language (0=English, 1=Japanese)
	0537	Send/read speech speed (0=slow, 1=fast)
	0538	Send/read S-level speech (0=OFF, 1=ON)
	0539	Send/read memo pad numbers (0=5 ch, 1=10 ch)
	0540	Send/read main dial auto TS (0=OFF, 1=Low, 2=High)
	0541	Send/read mic. up/down speed (0=Low, 1=High)
	0542	Send/read CI-V transceive set (0=OFF, 1=ON)
	0543	Send/read CI-V 731 mode set (0=OFF, 1=ON)
	0544	Send/read TX spectrum scope set (0=OFF, 1=ON)
0545	Send/read spectrum scope max. hold set (0=OFF, 1=ON)	
0546	Send/read voice auto monitor set (0=OFF, 1=ON)	

Command	Sub command	Description
1A	0547	Send/read cut number style (0=Normal, 1=190→ANO, 2=90→ON, 3=190→ANT, 4=90→NT)
	0548	Send/read count up trigger channel (1=M1, 2=M2, 3=M3, 4=M4)
	0549	Send/read present number (1-9999)
	0550	Send/read CW keyer repeat time (1=1 sec. to 60=60 sec.)
	0551	Send/read CW keyer dot/dash ratio (28=1:1:2.8 to 45=1:1:4.5)
	0552	Send/read rise time (0=2 msec., 1=4 msec., 2=6 msec., 3=8 msec.)
	0553	Send/read paddle polarity (0=Normal, 1=Reverse)
	0554	Send/read keyer type (0=Straight, 1=Bug-key, 2=ELEC-Key)
	0555	Send/read mic. up/down keyer set (0=OFF, 1=ON)
	0556	Send/read scan speed (0=low, 1=high)
	0557	Send/read scan resume (0=OFF, 1=ON)
	0558	Send/read VOX gain (0=0% to 255=100%)
	0559	Send/read anti VOX gain (0=0% to 255=100%)
	0560	Send/read VOX delay (0=0.0 sec. to 20=2.0 sec.)
	0561	Send/read RTTY filter bandwidth (0=250 Hz, 1=300 Hz, 2=350 Hz, 3=500 Hz, 4=1 kHz)
	0562	Send/read twin peak filter (0=OFF, 1=ON)
	0563	Send/read timer functions (0=OFF, 1=ON)
	0564	Send/read DSP filter type (0=SSB: sharp; CW: sharp, 1=SSB: sharp; CW: soft, 2=SSB: soft CW: sharp, 3=SSB: soft CW: soft)
	0565	Send/read quick RIT/ΔTX clear function (0=OFF, 1=ON)
	0566	Send/read SSB/CW synchronous tuning function (0=OFF, 1=ON)
0567	Send/read CW normal side set (0=LSB, 1=USB)	
0568	Send/read external keypad type (0=OFF, 1=Keyer send, 2=Voice play (Tx), 3=Auto)	
0569	Send/read NB level (0=0% to 255=100%)	
06	Send/read DATA mode (0=OFF, 1=ON)	
07	Send/read SSB transmit bandwidth (0=Wide, 1=Middle, 2=Narrow)	
1B	00	Set repeater tone frequency
	01	Set tone squelch tone frequency
1C	00	Set the transceiver to receive or transmit condition (0=Rx; 1=Tx)

4 of 4

• Data format

The CI-V system can be operated using the following data formats. Data formats differ according to command numbers. A data area or sub command is added for some commands.

IC-75 DSP

COMMAND TABLE

Description	Cn	Sc
Frequency control	05	Data
Operating mode and IF filter control	LSB	00*1
	USB	01*1
	AM	02*1
	CW	03*1
RTTY		04*1
	FM	05*2
VFO mode		-
MAIN ↔ SUB		B0
MAIN=SUB	07	B1
Dualwatch OFF		C0
Dualwatch ON		C1
Memory mode		-
Memory selection	08	mc*3
Memory write	09	-
Memory ▶ VFO	0A	-
Memory clear	0B	-
Scan stop		00
Start scan		01
Split OFF		00
Split ON		01
[TS] OFF (10 Hz step)		00
[TS] ON (1-10 kHz steps)	10	01-10
[ANT1] selection		00
[ANT2] selection	12	01
Electronic keyer input	17	Data

*1 Add "01" to select wide IF filters.
 Add "02" to select narrow IF filters.
 *2 Add "02" to select narrow IF filters.
 *3 Memory channel number (BCD)
 P1=0100, P2=0101

OK MESSAGE TO CONTROLLER

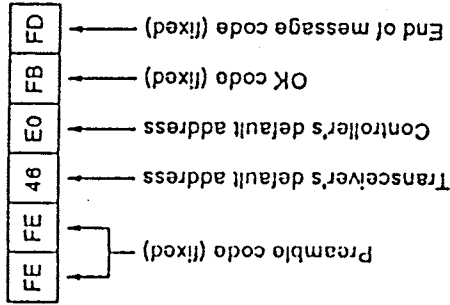

CONTROLLER TO IC-775/DSP

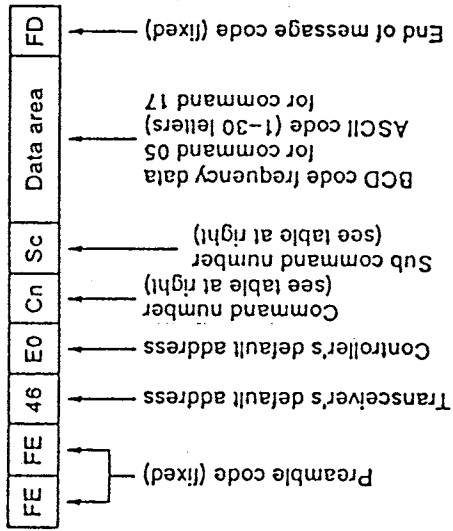

NG MESSAGE TO CONTROLLER

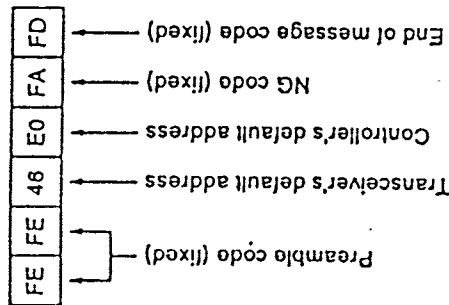

IC-775/DSP TO CONTROLLER

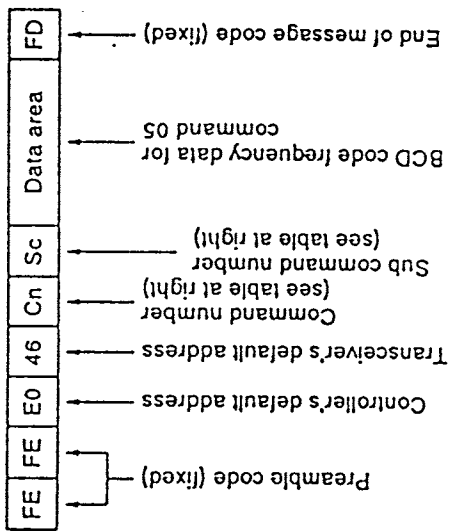

ASCII code for command 17.

- Acceptable characters: A-Z, 0-9, / ? . _ () and space

- " ^ " continues the next letter without a space; e.g. ^AR = AR.

*S*OS = SOS

Remote jack (CI-V) information

CI-V connection example

The transceiver can be connected through an optional CT-17 CI-V LEVEL CONVERTER to a personal computer equipped with an RS-232C port. The Icom Communication Interface-V (CI-V) controls the following functions of the transceiver.

Up to four Icom CI-V transceivers or receivers can be connected to a personal computer equipped with an RS-232C port. See p. 43 for setting the CI-V condition using the L-set mode.

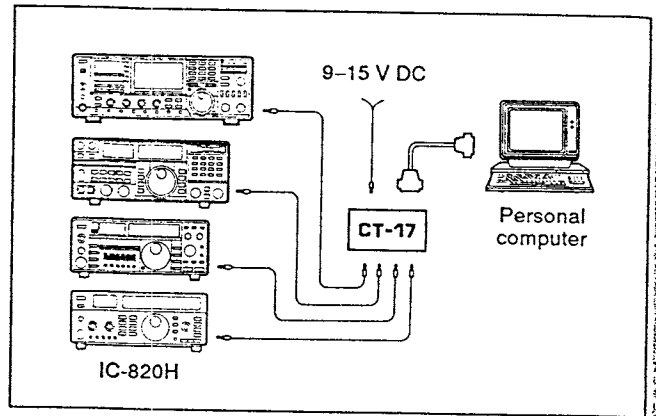

Data format

The CI-V system can be operated using the following data formats. Data formats differ according to command numbers. A data area is added for some commands.

CONTROLLER TO IC-820H

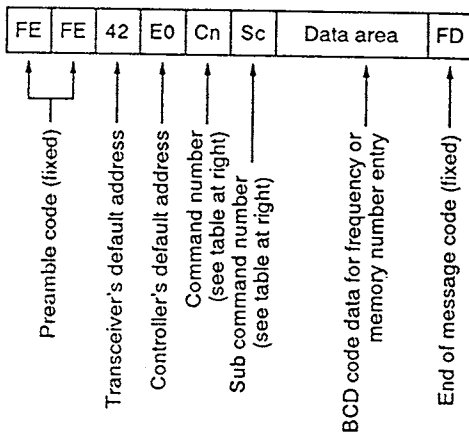

OK MESSAGE TO CONTROLLER

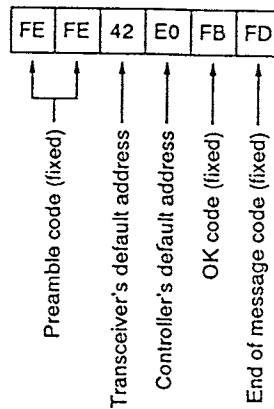

IC-820H TO CONTROLLER

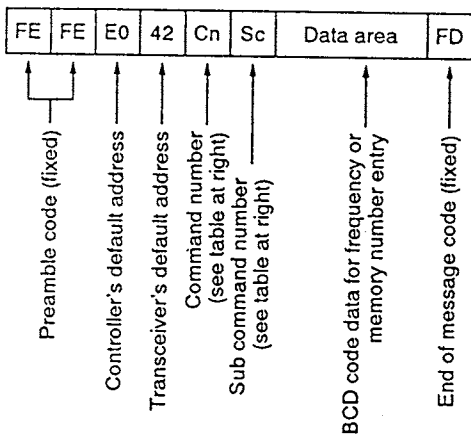

NG MESSAGE TO CONTROLLER

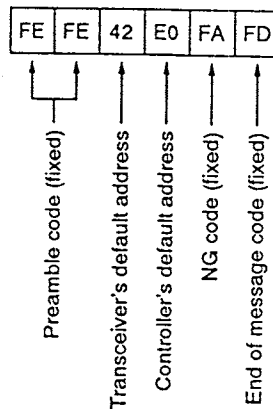

COMMAND TABLE

Description	Cn	Sc
Frequency control	05	-
Operating mode control	06	00
		01
		0301
		0302
FM		05
VFO mode		-
VFO A		00
VFO B		01
A=B	07	A0
MAIN/SUB		B0
Sub band access		D0
Main band access		D1
Memory mode		-
Memory selection	08	mc*
Memory write	09	-
Memory ▶ VFO	0A	-
Memory clear	0B	-
Offset read	0C	-
Offset write	0D	-
Scan stop		00
Start scan		0E
Start mode select scan		24
Split ON		00
Split OFF		01
Simplex selection	0F	10
Duplex - selection		11
Duplex + selection		12

* Memory channel number
P1=100, P2=101, CALL=102

AC-821A

The CI-V system can be operated using the following data formats. Data formats differ according to command numbers. A data area is added for some commands.

CONTROLLER TO IC-821H

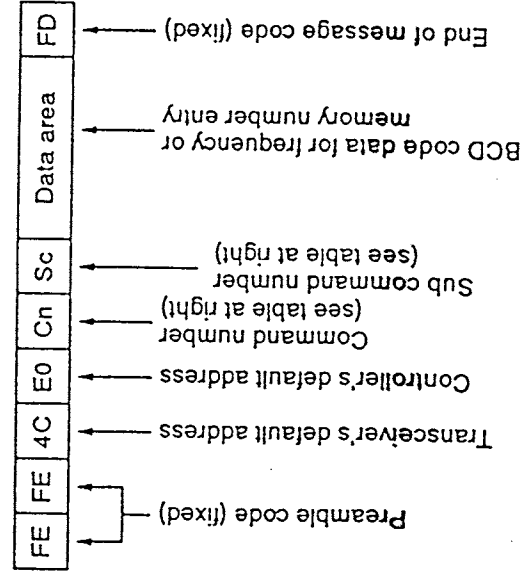

OK MESSAGE TO CONTROLLER

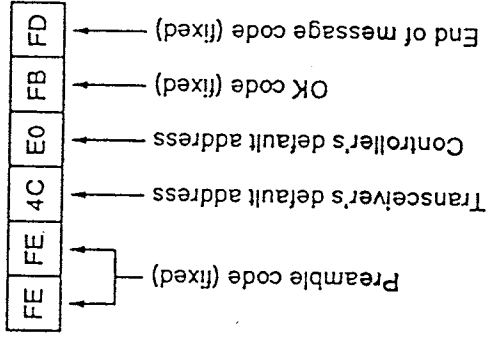

IC-821H TO CONTROLLER

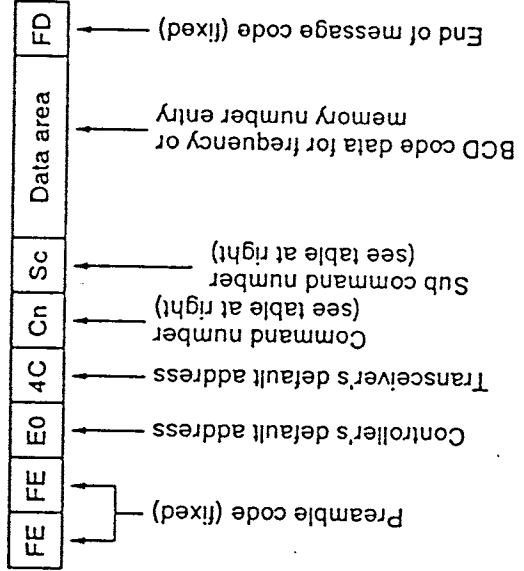

NG MESSAGE TO CONTROLLER

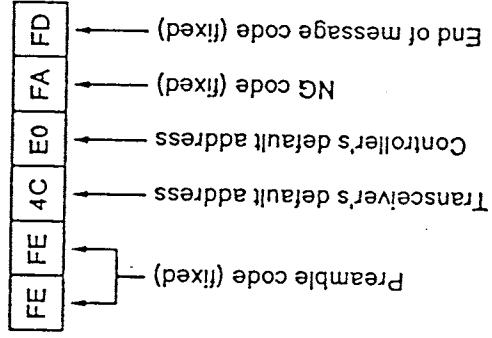

COMMAND TABLE

Description	Cn	Sc
Frequency control	05	-
Operating mode control	06	00 01 0301 0302 05
VFO mode		-
VFO A		00
VFO B		01
A=B	07	A0 B0 D0 D1
MAIN/SUB		
Main band access		
Sub band access		
Memory mode		-
Memory selection	08	mc*
Memory write	09	-
Memory ▶ VFO	0A	-
Memory clear	0B	-
Offset read	0C	-
Offset write	0D	-
Scan stop	0E	00
Start scan		01
Split OFF		00
Split ON		01
Simplex selection	0F	10
Duplex - selection		11
Duplex + selection		12

* Memory channel number
P1=0100, P2=0101, CALL=0102

821A

12 CONTROL COMMANDS

General

The IC-R10 can be connected to a PC via the PC's RS-232C port using an optional CT-17 CI-V LEVEL CONVERTOR. This allows you to control the receiver from the PC and/or transfer data from the receiver to the PC.

Control is provided via Icom's CI-V Communication Interface.

Data format

The CI-V system can be operated using the following data formats. Data formats differ according to command numbers. A data area is added for some commands.

Controller → IC-R10

FE	FE	52	E0	Cn	Sc	Data area	FD
①	②	③	④	⑤	⑥	⑦	

IC-R10 → Controller

FE	FE	E0	52	Cn	Sc	Data area	FD
①	③	②	④	⑤	⑥	⑦	

- ① Preamble code (fixed)
- ② Receiver's default address
- ③ Controller's default address
- ④ Command number (see table below)
- ⑤ Sub command number (see table below)
- ⑥ BCD code data for frequency entry
- ⑦ End of message code (fixed)

Command table

Description	Cn	Sc
Transfers frequency data (transceive)	00	—
Transfers mode data (transceive)	01	—
Reads display frequency	03	—
Reads display mode	04	—
Sets frequency data	05	—
Sets LSB mode		00
Sets USB mode		01
Sets AM mode	06	02
Sets CW mode		03
Sets FM mode		05
Sets WFM mode		06
Reads squelch condition (open or closed)	15	01
Reads S-meter level		02

R10

The IC-R8500 can be connected to a PC via the PC's RS-232C port. This allows you to control the receiver

from the PC and/or transfer data from the receiver to the PC.

Command table

Operation		Cn	Sc	Remark
Reading freq. edges		02	—	
Reading operating freq.		03	—	
Reading operating mode		04	—	
Reading M-ch contents package		1A	01	add bn+mc*
Reading bank name		1A	03	add bn*
Reading squelch condition		15	01	
Reading S-meter level			02	
Reading model ID		19	00	
Set frequency		05		add fd*
Set operating mode	LSB	06	0001	
	USB		0101	
	AM		0202	
	AM narrow		0201	
	AM wide		0203	
	CW		0301	
	CW narrow		0302	
	FM		0501	
FM narrow	0502			
WFM	0601			
Memory channel selection		08	—	mc*
Bank selection		A0	—	bn*
Memory write		09	—	
Set M-ch contents & write package		1A	00	add dt*
Set bank name		1A	02	add bn+nd*
Memory clear		0B	—	
Stop scan			00	
Programmed scan start			02	note 1
Auto memory write scan start			04	note 1
Memory scan start			22	note 2
Select memory scan start			23	note 2
Mode select scan start			24	note 2
Priority scan			42	
SEL-CH release			B0	
SEL-CH tag			B1	
VSC deactivation			C0	
VSC activation			C1	
Scan resume selection "∞"			D0	
Scan resume selection "OFF"			D1	
Scan resume selection "DLY"			D3	

Operation		Cn	Sc	Remark	
Tuning step	10 Hz	10		00	
	50 Hz			01	
	100 Hz			02	
	1 kHz			03	
	2.5 kHz			04	
	5 kHz			05	
	9 kHz			06	
	10 kHz			07	
	12.5 kHz			08	
	20 kHz			09	
	25 kHz			10	
	100 kHz			11	
	1 MHz programmable			12	
Attenuator	OFF	11		00	
	10 dB			10	
	20 dB			20	
	30 dB			30	
Voice synthesizer	frequency	13	00		
AF gain setting		14		01	add gd*
Squelch level setting				03	add gd*
IF shift setting				04	add gd*
APF control setting				05	add gd*
Memory clear	AGC OFF		16		10
	AGC ON			11	
	NB OFF			20	
	NB ON			21	
	APF OFF			30	
	APF ON			31	
Power OFF (activating sleep)		18		00	
Power ON (from sleep active)				01	

Note 1: Only scan group 0 is usable.

Note 2: Use these commands after sending a bank or m. command.

Data format

• Basic format from PC to IC-R8500

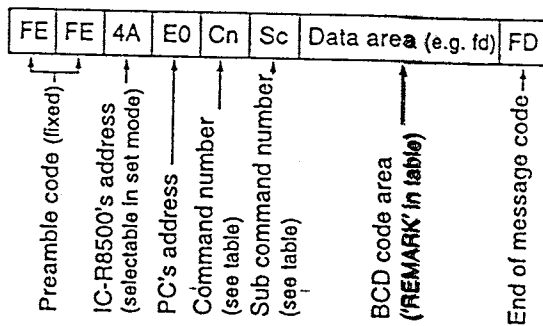

• Answer from IC-R8500 to PC

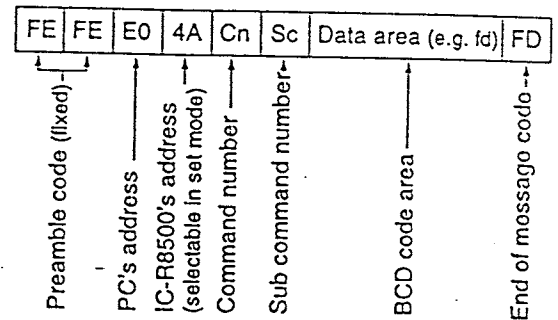

message from IC-R8500 to PC

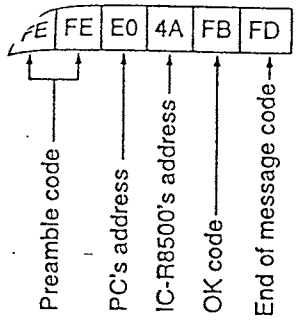

'NG' message from IC-R8500 to PC

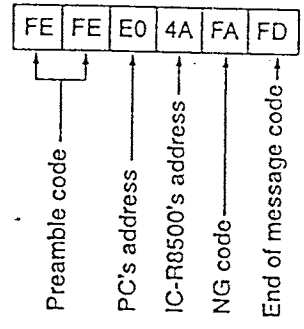

Memory channel contents set & write (1A 00)

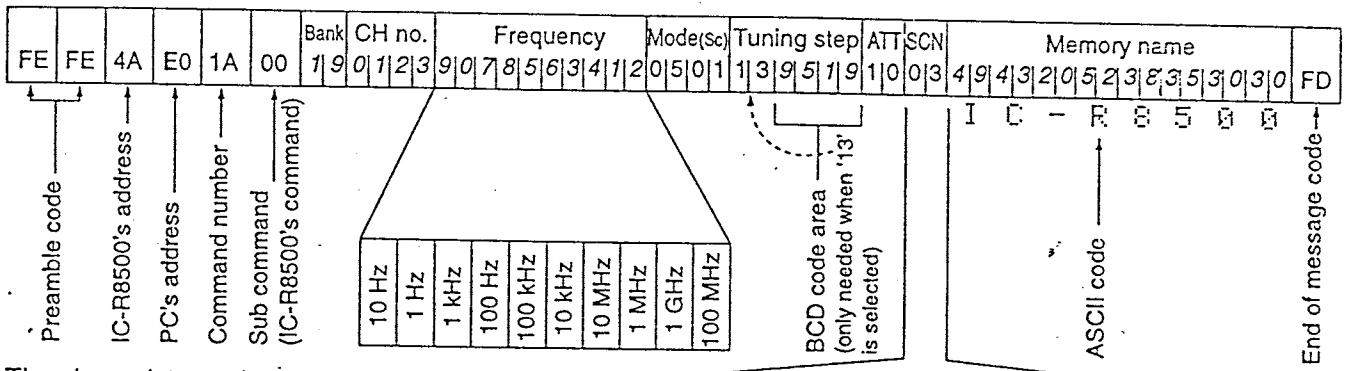

The above data packet is an example of programming the following into memory channel 123 of bank number 19:

- Frequency: 1,234,567,890 Hz
- Mode: FM
- Tuning step: 199.5 kHz (programmable step)
- Attenuator: 10 dB
- Scan select: specified
- Scan skip: specified
- Memory name: IC-R8500

Scan skip and select channels

Comment number	Scan select	Scan skip
00	OFF	OFF
01	OFF	Specified
02	Specified	OFF
03	Specified	Specified

Clearing the specified channel data (Memory channel contents set & write)

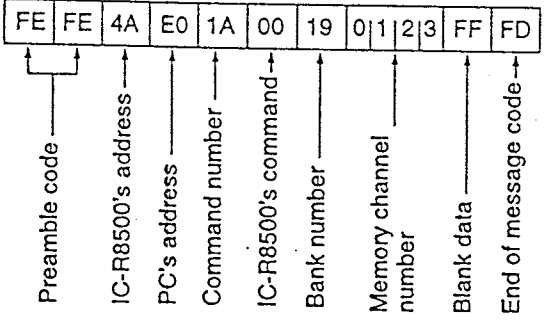

Special bank number and channels (bn)

Special bank	Bank number	Remarks
FREE	20	<ul style="list-style-type: none"> • For programmed scan, channel numbers are as follows: CP1=00, OP2=01, 1P1=02, 1P2=03, etc., up to 9P1=18 and 9P2=19. • There is only one channel in the priority bank.
AUTO	21	
SKIP	22	
PROG	23	
PRIO	24	

Gain and level data (gd; BCD data)

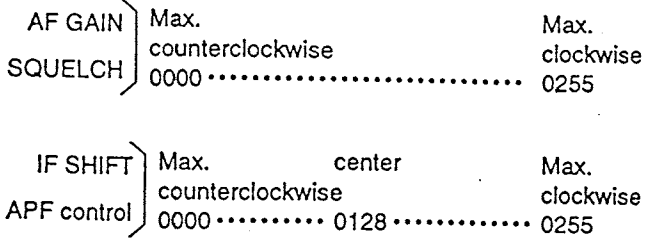

90H
10/23

Remote jack (CI-V) information

• CI-V connection example

The transceiver can be connected through an optional CT-17 CI-V LEVEL CONVERTER to a personal computer equipped with an RS-232C port. The Icom Communications Interface-V (CI-V) controls the following functions of the transceiver.

Up to 4 Icom CI-V transceivers or receivers can be connected to a personal computer equipped with an RS-232C port. See p. 59 for setting the CI-V condition using set mode.

• Data format

The CI-V system can be operated using the following data formats. Data formats differ according to command numbers. A data area or sub command is added for some commands.

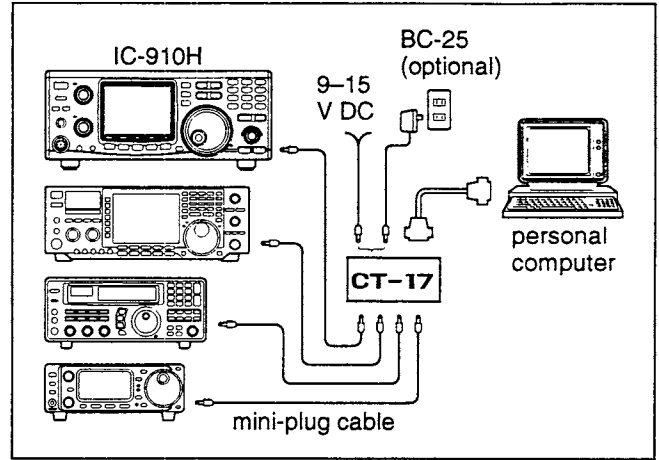

CONTROLLER TO IC-910H

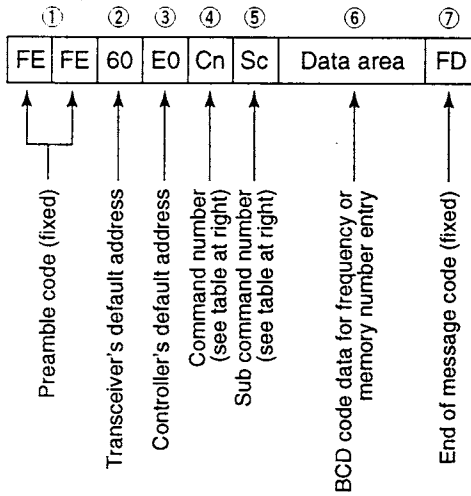

OK MESSAGE TO CONTROLLER



IC-910H TO CONTROLLER

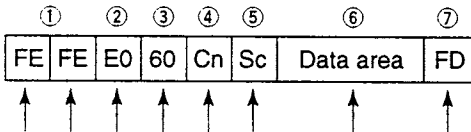

NG MESSAGE TO CONTROLLER

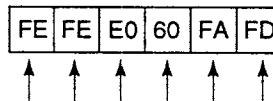

20FZ

Command	Sub command	Description
00	—	Send frequency data for transceive.
01	xx	Send mode data for transceive. Read band edge frequencies.
02	—	Read operating frequency data.
03	—	Read operating mode data.
04	—	Set operating frequency.
05	—	
06	00	Set LSB.
	01	Set USB.
	03	Set CW.
	04	Set FM.
07	—	Select VFO mode.
	00	Select VFO A.
	01	Select VFO B.
	A0	Equalize VFO A and VFO B.
	B0	Switch VFO A and VFO B.
	D0	Select MAIN VFO.
D1	Select SUB VFO.	
08	—	Select memory mode.
	01-0106*	Select memory channel. *1A=0100 1b=0101 2A=0102 2b=0103 3A=0104 3b=0105 Call=0106
09	—	Memory write.
0A	—	Transfer memory contents to VFO.
0B	—	Memory clear.
0C	—	Read duplex offset frequency.
0D	—	Set duplex offset frequency.
0E	00	Cancel scan.
	01	Start scan.
	D0	Set scan resume OFF.
	D3	Set scan resume ON.
0F	00	Turn the split function OFF.
	01	Turn the split function ON.
	10	Set simplex operation.
	11	Set DUP- operation.
12	Set DUP+ operation.	
10	00	Set 1 Hz tuning step.
	01	Set 10 Hz tuning step.
	02	Set 50 Hz tuning step.
	03	Set 100 Hz tuning step.
	04	Set 1 kHz tuning step.
	05	Set 5 kHz tuning step.
	06	Set 6.25 kHz tuning step.
	07	Set 10 kHz tuning step.
	08	Set 12.5 kHz tuning step.
	09	Set 20 kHz tuning step.
	10	Set 25 kHz tuning step.
11	Set 100 kHz tuning step.	
11	00	Turn attenuator OFF.
	20	Turn attenuator ON.

Command	Sub command	Description
13	00	Announce all S-meter level, displayed frequency and mode.
	01	Announce displayed frequency.
	02	Announce operating mode.
14	01	[AF] level setting (0=max. CCW; 128=center; 255=max. CW).
	02	[RF GAIN] level setting (0=max. CCW; 255=max. CW).
	03	[SQL] level setting (0=max. CCW; 255=max. CW).
	04	[IF SHIFT] level setting (0=max. CCW; 128=center; 255=max. CW).
	06	Set noise reduction level (0=0%; 255=100%).
	09	Set CW pitch (0=300 Hz; 255=900 Hz).
	0A	[RF PWR] level setting (0=max. CCW; 128=center; 255=max. CW).
	0B	[MIC GAIN] level setting (0=max. CCW; 128=center; 255=max. CW).
	0C	Key speed setting (0=6 wpm; 255=60 wpm).
	0E	Set mic. compressor level (0=0%; 255=100%).
	0F	Set break-in delay (0=2.0 sec; 255=13.0 sec.).
15	01	Read squelch condition (open or close).
	02	Read S-meter level.
16	02	Set pre-amp (0=OFF; 1=ON).
	12	Set AGC (0=Slow; 1=Fast)
	22	Set noise blanker (0=OFF; 1=ON).
	40	Set noise reduction level (0=OFF; 1-15=ON).
	+level data	
	41	Set auto notch filter (0=OFF; 1=ON).
	42	Set subaudible tone (0=OFF; 1=ON).
	43	Set tone squelch (0=OFF; 1=ON).
	44	Set mic. compressor (0=OFF; 1=ON).
	46	Set VOX (0=OFF; 1=ON).
47	Set break-in (0=OFF; 1=ON).	
4A	Set AFC (0=OFF; 1=ON).	
19	00	Read the transceiver ID.
1A	00	Read/write memory channel
	01	Set satellite memory.
	02	Set VOX gain level (0=0%; 255=100%)
	+level data	
	03	Set VOX delay (0=0 sec.; 20=2.0 sec.)
	+level data	
	04	Set anti VOX (0=0%; 255=100%)
	+level data	
05	Attenuation level setting (0=0%; 255=100%)	
06	Set RIT (0=OFF; 1=ON; 2=Sub dial).	
07	Set satellite mode (0=OFF; 1=ON).	
08	Set simple bandscope (0=OFF; 1=ON).	

IC-746

Command 1A	Individual Control ----- Execute the radio specific command	
---------------	---	--

Controller -> Radio

Pre Amble	Pre Amble	RX Address	TX Address	Command	Radio specific Command	This field is differ by the radio specific command	Post Amble
FE	FE	Radio Address	Controller Address	1A	xx (note 1)		FD

Note 1: See table1 below for radio specific commands

Operation in details

When controller sends correct radio specific command message, the radio will reply the radio specific command or "OK" data to the controller.

If the radio can not process the request from controller, the radio will reply "NG" to the controller

See command 5 for "OK" or "NG" packet

Table1 (Radio specific command for IC-746)

Command	Function	
00	Memory CH	Read or Set for Memory channel Read / Set
01	Band Stacking Register	Read or Set for Band stacking register Read/Set
02	Keyer Memory	Read or Set for Keyer memory Read/Set
03	9M,45k Filter	Read or Set for 9MHz / 455KHz filter Read/Set

MASTER
Do Not Remove
From Tech Support Area

MASTER
Do Not Remove
From Tech Support Area

Gerd
10/4

Command	Memory CH (The radio specific command)	READ
1A00	Read or Set for Memory channel	SET

IC-746 specific command

READ:

Controller -> Radio

Pre Amble	Pre Amble	RX Address	TX Address	Radio specific Command		Data	Post Amble
FE	FE	Radio Address	Controller Address	1A	00	xxxx	FD

Channel No

See table 2 below for the channel number conversion

Operation in details

If the command is valid, the radio will reply specified memory channel's contents to the controller

Radio -> Controller

Pre Amble	Pre Amble	RX Address	TX Address	Radio specific Command		Data	Post Amble
FE	FE	Controller Address	Radio Address	1A	00	xxxx x-x	FD

Channel No Contents

See table 2 below for channel number

See table 3 below for memory contents

If the radio can not process the request from controller, the radio will reply "NG" to the controller
See command 5 for "OK" or "NG" packet in details

SET:

Controller -> Radio

Pre Amble	Pre Amble	RX Address	TX Address	Radio specific Command		Data	Post Amble
FE	FE	Radio Address	Controller Address	1A	00	xxxx x-x	FD

Channel No Contents

See table 2 below for channel number

See table 3 below for memory contents

Operation in details

When controller sends correct radio specific command message, the radio will reply the radio specific command or "OK" data to the controller.

If the radio can not process the request from controller, the radio will reply "NG" to the controller
See command 5 for "OK" or "NG" packet

Table 2 (Channel number contents for 746)

Data	Channel Number
0001	1CH
0099	99CH
0100	P1
0101	P2
0102	CALL

You may not omit MSB data

Table 3 (Memory Channel Contents)

FRONT															
Split Select	10 1	1 100 k	100 10 k k	10 1 M M	1 100 G M	Mode	IF Width	DUP Tone	10 1 k k	100 10	1 0.1	10 1 k k	100 10	1 0.1	->
Note 4	Frequency					Mode	Tone Frequency			TSQL Frequency					
							Tone OFF / Tone ON / TSQL								
							DUP OFF / - / +								
BACK															
	10 1	1 100 k	100 10 k k	10 1 M M	1 100 G M	Mode	IF Width	DUP Tone	10 1 k k	100 10	1 0.1	10 1 k k	100 10	1 0.1	->
>	Frequency					Mode	Tone Frequency			TSQL Frequency					
							Tone OFF / Tone ON / TSQL								
							DUP OFF / - / +								
Alphanumeric Comments															
>	1	2	3	4	5	6	7	8	9						

Table 4 (SPLIT SELECT Contents)

Data	SPLIT	SELECT
00	OFF	OFF
01		ON
02	ON	OFF
03		ON

- P1, P2 can not turn on the SPLIT
(Means, it can not use BACK memory contents)
- P1, P2 and CALL can not turn on the SELECT

Table 5 (Mode Contents)

Data	Mode
00	LSB
01	USB
02	AM
03	CW

Data	Mode
04	RTTY
05	FM
06	WFM
07	CW-R

Data	Mode
08	RTTY-R
09	
10	

Data	IF Band Width
01	Wide
02	Narrow

is not available for 746

Table 6 (Mode / Tone Contents)

Data (MSB)	DUP	Data (LSB)	Tone	TSQL
0	DUP OFF	0	OFF	OFF
1	DUP -	1	ON	OFF
2	DUP +	2	OFF	ON

The data is 4 bit data

Tone (CTCSS Tone Encoding Frequencies)

The available CTCSS frequencies are

CTCSS 67.0 ~ 254.1 Hz or call tone 1750Hz

TSQL (CTCSS Tone Encoding and Decoding Frequencies)

The available CTCSS Frequencies are

CTCSS 67.0 ~ 254.1 Hz or call tone 1750Hz

Table 7 (Alphanumeric Comments contents)

See ASCII Table (Available Code is between 00h and EFh)

Table 8 (Blank)

FF

Command	Band Stacking Register (The radio specific command)	READ
1A 01	Read or Set for Band Stacking Register	SET

IC-746 Specific command

READ

Controller -> Radio

Pre Amble	Pre Amble	RX Address	TX Address	Radio specific Command		Data		Post Amble
FE	FE	Radio Address	Controller Address	1A	01	Band xx	Call No xx	FD
						BSR Number		

See table 9 below for the BSR number / Call number conversion

Operation in details

If the command is valid, the radio will reply specified band stacking register's contents to the controller

Radio -> Controller

Pre Amble	Pre Amble	RX Address	TX Address	Radio specific Command		Data		Post Amble
FE	FE	Controller Address	Radio Address	1A	01	Band	Call No	FD
						BSR No		BSR content

See table 9 below for the BSR number / Call number conversion

See table 10 below for the BSR contents conversion

If the radio can not process the request from controller, the radio will reply "NG" to the controller

See command 5 for "OK" or "NG" packet in details

SET:

Controller -> Radio

Pre Amble	Pre Amble	RX Address	TX Address	Radio specific Command		Data		Post Amble
FE	FE	Radio Address	Controller Address	1A	01	Band	Call No	FD
						BSR No		BSR content

See table 9 below for the BSR number / Call number conversion

See table 10 below for the BSR contents conversion

Operation in details

When controller sends correct radio specific command message, the radio will reply the radio specific command or "OK" data to controller.

If the radio can not process the request from controller, the radio will reply "NG" to the controller

See command 5 for "OK" or "NG" packet

Table 10 (BSR number / Call Number)

BAND						CALLNumber	
Data	Band	Frequency Range	Data	Band	Frequency Range	Data	Call NO
01	1.8	1.800000-1.999999	07	21	20.900000-21.499999	01	1
02	3.5	3.400000-4.099999	08	24	24.400000-25.099999	02	2
03	7	6.900000-7.499999	09	28	28.000000-29.999999	03	3
04	10	9.900000-10.499999	10	50	50.000000-54.000000		
05	14	13.900000-14.499999	11	144	144.000000-148.000000		
06	18	17.900000-18.499999	12	GENE	Other than above		

Table 11 (BSR Contents)

10 1	1 100	100 10	10 1	1 100	Mode	IF	DUP	10 1	100 10	1 0.1	10 1	100 10	1 0.1
k	k	k k	MM	GM		Width	Tone	k k			k k		
Frequency					Mode		Tone Frequency			TSQL Frequency			
							Tone OFF / Tone ON / TSQL						
							DUP OFF / - / +						

Table 12 (Mode Contents)

Data	Mode	Data	Mode	Data	Mode	Data	IF Band Width
00	LSB	04	RTTY	08	RTTY-R	01	Wide
01	USB	05	FM	09		02	Narrow
02	AM	06	WFM	10		is not available for 746	
03	CW	07	CW-R				

Table 13 (Mode / Tone Contents)

Data (MSB)	DUP	Data (LSB)	Tone	TSQL
0	DUP OFF	0	OFF	OFF
1	DUP -	1	ON	OFF
2	DUP +	2	OFF	ON

The data is 4 bit data

Tone (CTCSS Tone Encoding Frequencies)

The available CTCSS frequencies are

CTCSS 6 7. 0 ~ 2 5 4. 1 H z or call tone 1750Hz

TSQL (CTCSS Tone Encoding and Decoding Frequencies)

The available CTCSS Frequencies are

CTCSS 6 7. 0 ~ 2 5 4. 1 H z or call tone 1750Hz

Command	Keyer Memory (The radio specific command)	READ
1A 02	Read or Set for Keyer memory	SET

IC-746 specific command

READ:

Controller -> Radio

Pre Amble	Pre Amble	RX Address	TX Address	Radio specific Command		Data	Post Amble
FE	FE	Radio Address	Controller Address	1A	02	10 1 xxxx	FD
						Channel No	

See table 14 below for the channel number conversion

Operation in details

If the command is valid, the radio will reply specified keyer's memory channel's contents to the controller

Radio -> Controller

Pre Amble	Pre Amble	RX Address	TX Address	Radio specific Command		Data	Post Amble
FE	FE	Controller Address	Radio Address	1A	02	10 1 xxxx	Text 1- 50 characters FD
						Channel No	Contents

See table 14 below for channel number
See table 15 below for memory contents

If the radio can not process the request from controller, the radio will reply "NG" to the controller
See command 5 for "OK" or "NG" packet in details

SET:

Controller -> Radio

Pre Amble	Pre Amble	RX Address	TX Address	Radio specific Command		Data	Post Amble
FE	FE	Radio Address	Controller Address	1A	02	10 1 xxxx	Text 1-50 characters FD
						Channel No	Contents

See table 14 below for channel number
See table 15 below for memory contents

Operation in details

When controller sends correct radio specific command message, the radio will reply the radio specific command or "OK" data to the controller.

If the radio can not process the request from controller, the radio will reply "NG" to the controller
See command 5 for "OK" or "NG" packet

Table 14 (Keyer Memory Channel Number)

Data	Channel No
01	M1
02	M2
03	M3
04	M4

Table 15 (Keyer Memory Channel Contents)
Up to 50 ASCII characters

Available characters

Character	ASCII Code	Details
0-9	30-39	
A-Z a-z	41-5A 61-7A	
(Space)	20	
/ ? , .	2F 3F 2C 2E	
~	5E	Starting no code space in word or sentence
*	2A	Inserting contact number

- You may omit space after the end of sentence (To clear the memory, you will need at least one space character)
- If you want to set contact number, you will need to erase other contact number in other channel

MASTER
Do Not Remove
From Tech Support Area

Command	9MHz 455KHz Filter (The radio specific command)	READ
1A 03	Read or Set for 9MHz or 455KHz filter	SET

IC-746 specific command

READ:

Controller -> Radio

Pre Amble	Pre Amble	RX Address	TX Address	Radio specific Command		Post Amble
FE	FE	Radio Address	Controller Address	1A	03	FD

Operation in details

If the command is valid, the radio will reply the selection of 9MHz and 455KHz filter to the controller

Radio -> Controller

Pre Amble	Pre Amble	RX Address	TX Address	Radio specific Command		Data		Post Amble
FE	FE	Controller Address	Radio Address	1A	03	9MHz Filter	455KHz Filter	FD

If the radio can not process the request from controller, the radio will reply "NG" to the controller
See command 5 for "OK" or "NG" packet in details

SET:

Controller -> Radio

Pre Amble	Pre Amble	RX Address	TX Address	Radio specific Command		Data		Post Amble
FE	FE	Radio Address	Controller Address	1A	03	9MHz Filter	455KHz Filter	FD

Operation in details

When controller sends correct radio specific command message, the radio will reply the radio specific command or "OK" data to the controller.

If the radio can not process the request from controller, the radio will reply "NG" to the controller
See command 5 for "OK" or "NG" packet

MASTER
Do Not Remove
From Tech Support Area

Table 16

	Narrow	Wide
LSB, USB		
CW, CW-R		
RTTY, RTTY-R		
AM		
FM		

Table 17

Data	9MHz Filter	Data	455KHz Filter
00	15KHz	00	15KHz
01	2.8KHz (FL-103)	01	9KHz
02	2.4KHz	02	3.3KHz (FL-257)
03	1.9KHz (FL-223)	03	2.8KHz (FL-96)
04	500Hz (FL-100)	04	2.4KHz
05	350Hz (FL-232)	05	1.8KHz (FL-222)
06	250Hz (FL-101)	06	500Hz (FL-52A)
		07	250Hz (FL-53A)

is optional filters. However available slot for optional filter is limited
 9MHz = one
 455KHz = two

MASTER
 Do Not Remove
 From Tech Support Area

Command	CTCSS Tone / TSQL Frequency	READ
1B	Read or Set for CTCSS tone/TSQL frequency	SET

Sub-Command		Details
00	Tone frequency	CTCSS encoder frequency
01	TSQL frequency	CTCSS encoder/decoder frequency

READ:

Controller -> Radio

Pre Amble	Pre Amble	RX Address	TX Address	Command	Sub Command	Post Amble
FE	FE	Radio Address	Controller Address	1B	xx	FD

Operation in details

If the command is valid, the radio will reply CTCSS tone or Tone SQL frequency to the controller

Radio -> Controller

Pre Amble	Pre Amble	RX Address	TX Address	Command	Sub Command	Data	Post Amble
FE	FE	Controller Address	Radio Address	1B	xx	10 1 k k 100 10 1 0.1	FD

CTCSS Frequency

If the radio can not process the request from controller, the radio will reply "NG" to the controller
See command 5 for "OK" or "NG" packet in details

SET:

Controller -> Radio

Pre Amble	Pre Amble	RX Address	TX Address	Command	Sub Command	Data	Post Amble
FE	FE	Radio Address	Controller Address	1B	xx	10 1 k k 100 10 1 0.1	FD

CTCSS Frequency

Note: You may omit MSB oh it is "0"

Operation in details

When controller sends correct radio specific command message, the radio will reply the radio specific command or "OK" data to the controller.

If the radio can not process the request from controller, the radio will reply "NG" to the controller
See command 5 for "OK" or "NG" packet

Following table is available CTCSS tone frequency for iC-746

67.0	94.8	131.8	171.3	203.5	150.0
69.3	97.4	136.5	173.8	206.5	1750
71.9	100.0	141.3	177.3	210.7	
74.4	103.5	146.2	179.9	218.1	
77.0	107.2	151.4	183.5	225.7	
79.7	110.9	156.7	186.2	229.1	
82.5	114.8	159.8	189.9	233.6	
85.4	118.8	162.2	192.8	241.8	
88.5	123.0	165.5	196.6	250.3	
91.5	127.3	167.9	199.5	254.1	

- 1750 is European Tone (Encode only)

Command 1C	TX	READ SET
	Read or Set for Transmit condition	

Sub-Command		Details
00	TX	Transmit mode ON/OFF (TR or RX)

READ:

Controller -> Radio

Pre Amble	Pre Amble	RX Address	TX Address	Command	Sub Command	Post Amble
FE	FE	Radio Address	Controller Address	1C	00	FD

Operation in details

If the command is valid, the radio will reply the transmit ON/OFF condition to the controller

Radio -> Controller

Pre Amble	Pre Amble	RX Address	TX Address	Command	Sub Command	Data	Post Amble
FE	FE	Controller Address	Radio Address	1C	00	Transmit ON / OFF	FD

If the radio can not process the request from controller, the radio will reply "NG" to the controller
See command 5 for "OK" or "NG" packet in details

SET:

Controller -> Radio

Pre Amble	Pre Amble	RX Address	TX Address	Command	Sub Command	Data	Post Amble
FE	FE	Radio Address	Controller Address	1C	00	Transmit ON / OFF	FD

Operation in details

When controller sends correct radio specific command message, the radio will reply the radio specific command or "OK" data to the controller.

If the radio can not process the request from controller, the radio will reply "NG" to the controller
See command 5 for "OK" or "NG" packet

Following data is Transmit condition

Data	TX Mode
00	OFF
01	ON

MASTER
Do Not Remove
From Tech Support Area

Note:

Reading Transmit condition:

- If the radio is held PTT for transmit mode (Even no RF signals are came out from radio due to the out band frequencies), the radio will reply the "TX ON" to the controller

Setting Transmit condition:

- The radio can request transmit on or off by this command. However radio PTT (Hardware PTT) is held, the radio will not return to receive mode until release.

Remote jack (CI-V) information

CI-V connection example

The transceiver can be connected through an optional CT-17 CI-V LEVEL CONVERTER to a personal computer equipped with an RS-232C port. The Icom Communication interface-V (CI-V) controls the following functions of the transceiver.

Up to four Icom CI-V transceivers or receivers can be connected to a personal computer equipped with an RS-232C port. See p. 82 for setting the CI-V condition using initial set mode.

Data format

The CI-V system can be operated using the following data formats. Data formats differ according to command numbers. A data area is added for some commands.

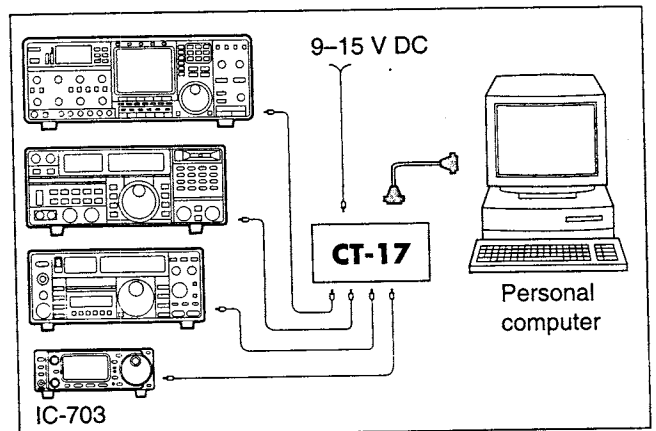

CONTROLLER TO IC-703

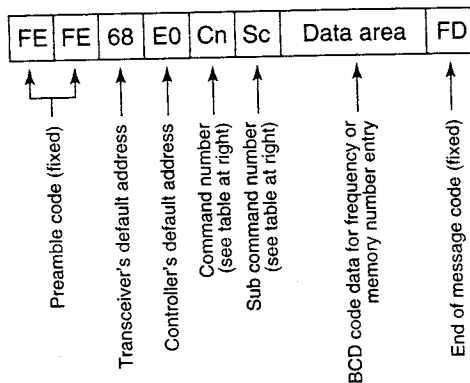

OK MESSAGE TO CONTROLLER

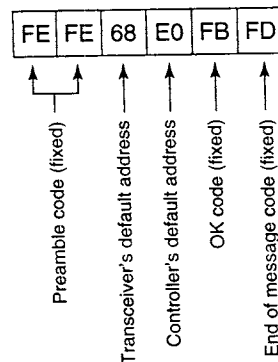

IC-703 TO CONTROLLER

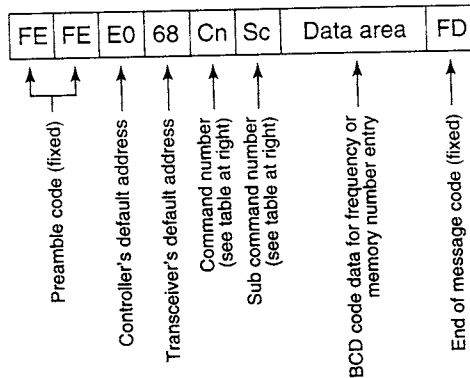

NG MESSAGE TO CONTROLLER

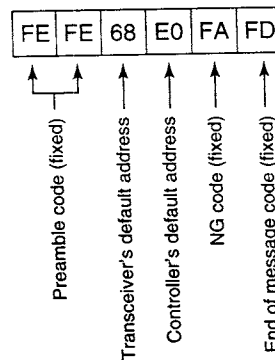

703

◇ Command table

Command	Sub command	Description
00	—	Send frequency data
01	Same as command 06	Send mode data
02	—	Read band edge frequencies
03	—	Read operating frequency
04	—	Read operating mode
05	—	Set operating frequency
06	00	Select LSB
	01	Select USB
	02	Select AM
	03	Select CW
	04	Select RTTY
	05	Select FM
	07	Select CW-R
	08	Select RTTY-R
07	—	Select VFO mode
	00	Select VFO A
	01	Select VFO B
	A0	Equalize VFO A and VFO B
	B0	Exchange VFO A and VFO B
08	—	Select memory mode
	0001-0105*	Select memory channel *1A=0100, 3b=0105
09	—	Memory write
0A	—	Memory to VFO
0B	—	Memory clear
0E	00	Scan stop
	01	Programmed/memory scan start
0F	00	Turn the split function OFF
	01	Turn the split function ON
10	00	Select 10 Hz (1 Hz) tuning step
	01	Select 100 Hz tuning step
	02	Select 1 kHz tuning step
	03	Select 5 kHz tuning step
	04	Select 9 kHz tuning step
	05	Select 10 kHz tuning step
	06	Select 12.5 kHz tuning step
	07	Select 20 kHz tuning step
	08	Select 25 kHz tuning step
	09	Select 100 kHz tuning step
11	—	Select/read attenuator (00=OFF, 20=ON (20 dB))
13	00	Announce with voice synthesizer
	01	(00=all data; 01=frequency and S-meter level; 02=operating mode)
	02	
14	01 + Level data	[AF] level setting (0=max. CCW to 255=max. CW)
	02 + Level data	[RF] level setting (0=max. CCW to 255=11 o'clock)
	03 + Level data	[SQL] level setting (0=11 o'clock to 255=max. CW)
	04 + Level data	[IF SHIFT] position setting (0=max. CCW; 128=center; 255=max. CW)
	06 + Level data	Noise reduction level setting (0=min. to 255=max.)
	07 + Level data	Twin PBT (inside) setting (0=max. CCW; 128=center; 255=max. CW)
	08 + Level data	Twin PBT (outside) setting (0=max. CCW; 128=center; 255=max. CW)
	09 + Level data	CW pitch setting (0=300 Hz, 128=600 Hz, 255=900 Hz)

Command	Sub command	Description	
14	0A + Level data	RF power setting (0=min. to 255=max.)	
	0B + Level data	Microphone gain setting (0=min. to 255=max.)	
	0C + Level data	Key speed setting (0=slow to 255=fast)	
	0E + Level data	COMP Level setting (0=0 to 10=10)	
	0F + Level data	Break-IN DELAY setting (20=2.0d to 130=13.0d)	
	15	01	Read squelch condition
02		Read S-meter level	
11		Read RF power meter	
12		Read SWR meter	
13		Read ALC meter	
16		02	Preamp (0=OFF; 1=preamp 1; 2=preamp 2)
	12	AGC selection (1=Fast; 2=Slow)	
	22	Noise blanker (0=OFF; 1=ON)	
	40	Noise reduction (0=OFF; 1=ON)	
	41	Auto notch (0=OFF; 1=ON)	
	42	Subaudible tone (0=OFF; 1=ON)	
	43	Tone squelch (0=OFF; 1=ON)	
	44	Speech compressor (0=OFF; 1=ON)	
	45	Monitor (0=OFF; 1=ON)	
	46	VOX function (0=OFF; 1=ON)	
	47	Break-in (0=OFF; 1=semi break-in; 2=full break-in)	
	19	00	Read the transceiver ID
	1A	00	Send/read memory contents
01		Send/read band stacking register contents (see p. 73 for details)	
02		Send/read memory keyer contents (see p. 73 for details)	
0301		Send/read beep emission set (0=OFF, 1=ON)	
0302		Send/read band edge beep set (0=OFF, 1=ON)	
0303		Send/read beep output level set (0=min. to 255=max.)	
0304		Send/read beep limit set (0=OFF, 1=ON)	
0305		Send/read CW carrier point set (0=LSB, 1=USB)	
0306		Send/read CW side tone level set (0=min. to 255=max.)	
0307		Send/read CW side tone limit set (0=OFF, 1=ON)	
0308		Send/read 9600 bps mode set (0=OFF, 1=ON)	
0309		Send/read VOX gain set (0=min. to 255=max.)	
0310		Send/read anti VOX gain set (0=min. to 255=max.)	
0311	Send/read VOX delay time set (0=0 sec. to 20=2.0 sec.)		
0312	Send/read meter selection (0=Power, 1=SWR, 3=ALC)		
0313	Send/read SSB carrier frequency (00=-200 Hz to 40=200 Hz; 10 Hz steps)		

CW: Clockwise, CCW: Counter Clockwise

Command table (continued)

Command	Sub command	Description
1A	0314	Send/read RTTY marker frequency (0=1275 Hz, 1=1615 Hz, 2=2125 Hz)
	0315	Send/read RTTY shift width (0=170 Hz, 1=200 Hz, 2=425 Hz)
	0316	Send/read RTTY keying polarity (0=Normal, 1=Reverse)
	0317	Send/read noise blanker level (0=min. to 255=max.)
	0318	Send/read key type (0=Normal, 1=Reverse, 2=Bug, 3=OFF, 4=Mic. [UP]/[DN])
	0319	Send/read CW keyer dot/dash ratio (28=1:1.2.8 to 45=1:1.4.5)
	0320	Send/read CW keyer repeat time (01=1 sec. to 60=60 sec.)
	0321	Send/read CW keyer transmission indication (0=Normal, 1=First 3-character, 2= First 3-character+ contact number)
	0322	Send/read contact number style (0=Normal, 1=190→ANO, 2=190→ANT, 3=90→NO, 4=90→NT)
	0323	Send/read count up trigger channel (1=MK1, 2=MK2, 3=MK3)
0324	Send/read present number (1-999)	
1B	04	Send/read DATA mode (0=OFF, 1=ON)
	00	Set/read repeater tone frequency
1C	01	Set/read TSQL tone frequency
	00	Set/read the transceiver's condition (0=Rx; 1=Tx)
	01	Set/read antenna tuner condition (0=OFF, 1=ON, 2=Start tuning or while tuning)

◇ Band stacking register

To send or read the desired band stacking register's contents, combined code of the frequency band and register codes as follows are used.

For example, when sending/reading the contents in the 21 MHz band, the code "0701" is used.

• Frequency band code

Code	Freq. band	Frequency range (unit: MHz)
01	1.8	1.800000-1.999999
02	3.5	3.400000-4.099999
03	7	6.900000-7.499999
04	10	9.900000-10.499999
05	14	13.900000-14.499999
06	18	17.900000-18.499999
07	21	20.900000-21.499999
08	24	24.400000-25.099999
09	28	28.000000-29.999999
10	50	50.000000-54.000000
11	GENE	Other than above

• Register code

Code	Registered number
01	1

◇ Codes for memory keyer contents

To send or read the desired memory keyer contents, the channel and character codes as follows are used.

• Channel code

Code	Channel number
01	MK1
02	MK2
03	MK3

• Character's code

Character	ASCII code	Description
0-9	30-39	Numerals
A-Z	41-5A	Alphabetical characters
space	20	Word space
/	2F	Symbol
?	3F	Symbol
,	2C	Symbol
.	2E	Symbol
^	5E	e.g., to send \overline{B} , enter ^4254
*	2A	Inserts contact number (can be used for 1 channel only)

◇ Codes for memory name contents

To send or read the desired memory name settings, the character codes, instructed codes for memory keyer contents as above, and follows are additionally used.

• Character's code— Alphabetical characters

Character	ASCII code	Character	ASCII code
a-z	61-7A	—	—

• Character's code— Symbols

Character	ASCII code	Character	ASCII code
!	21	#	23
\$	24	%	25
&	26	¥	5C
?	3F	"	22
'	27	`	60
+	2B	-	2D
:	3A	;	3B
=	3D	<	3C
>	3E	(28
)	29	[5B
]	5D	{	7B
}	7D		7C
_	5F	~	7E

- Remote jack (CI-V) information 14-2
 - ◇ CI-V connection example 14-2
 - ◇ Data format 14-2
 - ◇ Command table 14-9
 - ◇ To send/read memory contents 14-9
 - ◇ Band stacking register 14-9
 - ◇ Codes for memory keyer contents 14-9
 - ◇ Codes for memory name, opening message
and clock 2 name contents 14-9
 - ◇ Offset frequency setting 14-10
 - ◇ Repeater tone/tone squelch frequency setting 14-10
 - ◇ SSB transmission passband width setting 14-10
 - ◇ Color setting 14-10
 - ◇ Bandscope edge frequency setting 14-10
 - ◇ Data mode with filter width setting 14-10
 - ◇ Antenna memory setting 14-10

Remote jack (CI-V) information

CI-V connection example

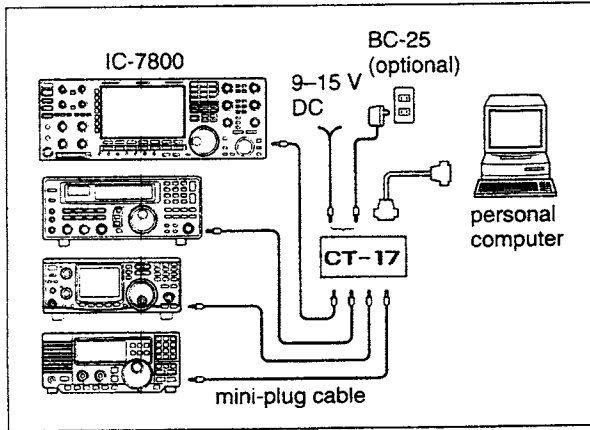

The transceiver can be connected through an optional CT-17 CI-V LEVEL CONVERTER to a PC equipped with an RS-232C port. The Icom Communications Interface-V (CI-V) controls the following functions of the transceiver.

Up to 4 Icom CI-V transceivers or transceivers can be connected to a PC equipped with an RS-232C port. See pgs. 12-18, 12-19 for setting the CI-V condition using set mode.

Data format

The CI-V system can be operated using the following data formats. Data formats differ according to command numbers. A data area or sub command is added for some commands.

Controller to IC-7800

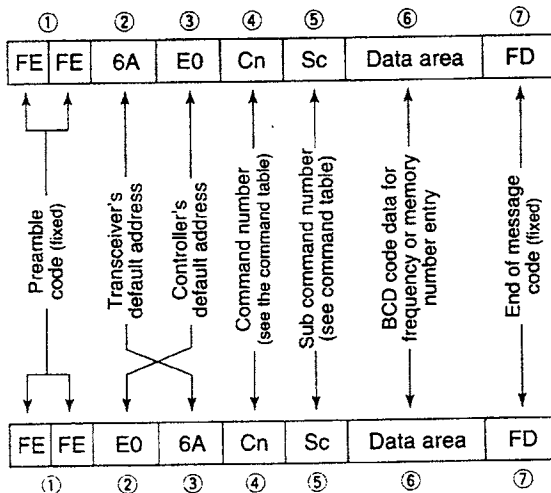

IC-7800 to controller

OK message to controller

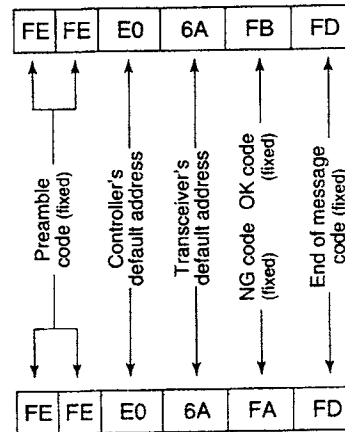

NG message to controller

◇ Command table

Command	Sub command	Description
00	—	Send frequency data
01	Same as command 06	Send mode data
02	—	Read band edge frequencies
03	—	Read operating frequency
04	—	Read operating mode
05	—	Set operating frequency
06	00 01 02 03 04 05 07 08 12 13	Select LSB Select USB Select AM Select CW Select RTTY Select FM Select CW-R Select RTTY-R Select PSK Select PSK-R
07	— B0 B1 C0 C1 D0 D1	Select VFO mode Exchange main and sub bands Equalize main and sub bands Turn the dualwatch OFF Turn the dualwatch ON Select main band Select sub band
08	— 0001-0101*	Select memory mode Select memory channel *P1=0100, P2=0101
09	—	Memory write
0A	—	Memory to VFO
0B	—	Memory clear
0E	00 01 02 03 12 13 22 23 A1-A7 B0 B1 B2 D0 D3	Scan stop Programmed/memory scan start Programmed scan start Δ F scan start Fine programmed scan start Fine Δ F scan start Memory scan start Select memory scan start Set Δ F scan span (A1= \pm 5 kHz; A2= \pm 10 kHz; A3= \pm 20 kHz; A4= \pm 50 kHz; A5= \pm 100 kHz; A6= \pm 500 kHz; A7= \pm 1 MHz) Set as non-select channel Set as select channel (1= \star 1; 2= \star 2; 3= \star 3; when no data com- mand is specified, the previously set number or " \star 1" is selected) Set the number for select memory scan (0=ALL; 1= \star 1; 2= \star 2; 3= \star 3) Set scan resume OFF Set scan resume ON
0F	00 01	Turn the split function OFF Turn the split function ON
10	00 01 02 03 04 05 06 07 08	Select 10 Hz (1 Hz) tuning step Select 100 Hz tuning step Select 1 kHz tuning step Select 5 kHz tuning step Select 9 kHz tuning step Select 10 kHz tuning step Select 12.5 kHz tuning step Select 20 kHz tuning step Select 25 kHz tuning step

Command	Sub command	Description
11	—	Select/read attenuator (0=OFF; 1=3 dB; 2=6 dB; 3=9 dB; 4=12 dB; 5=15 dB; 6=18 dB; 7=21 dB)
12	00 + RX ANT 01 + RX ANT 02 + RX ANT 03 + RX ANT	Select/read ANT1 selection (00=RX ANT OFF; 01=RX ANT ON) Select/read ANT2 selection (00=RX ANT OFF; 01=RX ANT ON) Select/read ANT3 selection (00=RX ANT OFF; 01=RX ANT ON) Select/read ANT4 selection (00=RX ANT OFF; 01=RX ANT ON)
13	00 01 02	Announce with voice synthesizer (00=all data; 01=frequency and S-meter level; 02=receive mode)
14	01 + Level data 02 + Level data 03 + Level data 05 + Level data 06 + Level data 07 + Level data 08 + Level data 09 + Level data 0A + Level data 0B + Level data 0C + Level data 0D + Level data 0E + Level data 0F + Level data 11 + Level data 12 + Level data 13 + Level data 14 + Level data 15 + Level data 16 + Level data 17 + Level data 18 + Level data 19 + Level data	[AF] level setting (0=max. CCW to 255=max. CW) [RF] level setting (0=max. CCW to 255=11 o'clock) [SQL] level setting (0=11 o'clock to 255=max. CW) [APF] level setting (0=Pitch-550 Hz, 128=Pitch. 255=Pitch+550 Hz) [NR] level setting (0=min. to 255=max.) Inside [TWIN PBT] setting or IF shift setting (0=max. CCW, 128=center, 255=max. CW) Outside [TWIN PBT] setting (0=max. CCW, 128=center, 255=max. CW) [CW PITCH] setting (0=300 Hz, 128=600 Hz, 255=900 Hz: 25 Hz steps) [RF POWER] setting (0=max. CCW to 255=max. CW) [MIC] setting (0=max. CCW to 255=max. CW) [KEY SPEED] setting (0=max. CCW to 255=max. CW) [NOTCH] setting (0=low freq. to 255=high freq.) [COMP] setting (0=max. CCW to 255=max. CW) [DELAY] setting (0=max. CCW to 255=max. CW) [AGC] control setting (0=max. CCW to 255=max. CW) [NB] control setting (0=max. CCW to 255=max. CW) [DIGI-SEL] setting (0=max. CCW to 255=max. CW) [DRIVE] setting (0=max. CCW to 255=max. CW) [MONI GAIN] setting (0=max. CCW to 255=max. CW) [VOX GAIN] setting (0=max. CCW to 255=max. CW) [ANTI VOX] setting (0=max. CCW to 255=max. CW) [CONTRAST] setting (0=max. CCW to 255=max. CW) [BRIGHT] setting (0=max. CCW to 255=max. CW)

◆ Command table (continued)

Command	Sub command	Description
15	01	Read squelch condition
	02	Read S-meter level
	11	Read RF power meter
	12	Read SWR meter
	13	Read ALC meter
	14	Read COMP meter
	15	Read Vd meter
	16	Read Ip meter
16	02	Preamp (0=OFF; 1=preamp 1; 2=preamp 2)
	12	AGC selection (0=OFF; 1=Slow; 2=Mid; 3=Fast)
	22	Noise blanker (0=OFF; 1=ON)
	32	Audio peak filter (0=OFF; 1=320 Hz; 2=160 Hz; 3=80 Hz)
	40	Noise reduction (0=OFF; 1=ON)
	41	Auto notch (0=OFF; 1=ON)
	42	Repeater tone (0=OFF; 1=ON)
	43	Tone squelch (0=OFF; 1=ON)
	44	Speech compressor (0=OFF; 1=ON)
	45	Monitor (0=OFF; 1=ON)
	46	VOX function (0=OFF; 1=ON)
	47	Break-in (0=OFF; 1=semi break-in; 2=full break-in)
	48	Manual notch (0=OFF; 1=ON)
	4C	VSC (0=OFF; 1=ON)
	4D	Manual AGC (0=OFF; 1=ON)
	4E	DIGI-SEL (0=OFF; 1=ON)
	4F	Twin peak filter (0=OFF; 1=ON)
	50	Dial lock (0=OFF; 1=ON)
19	00	Read the transceiver ID
1A	00	Send/read memory contents (see p. 14-9 for details)
	01	Send/read band stacking register contents (see p. 14-9 for details)
	02	Send/read memory keyer contents (see p. 14-9 for details)
	03	Send/read the selected filter width (SSB, CW, PSK: 0=50 Hz to 40=3600 Hz; RTTY: 0=50 Hz to 31=2700 Hz; AM: 0=200 Hz to 49=10 kHz)
	04	Send/read the selected AGC time constant (0=OFF, 1=0.1/0.3 sec. to 13=6.0/8.0 sec.)
	050001	Send/read SSB TX Tone (Bass) level (0=-5 to 10=+5)
	050002	Send/read SSB TX Tone (Treble) level (0=-5 to 10=+5)
	050003	Send/read SSB RX Tone (Bass) level (0=-5 to 10=+5)
	050004	Send/read SSB RX Tone (Treble) level (0=-5 to 10=+5)
	050005	Send/read AM TX Tone (Bass) level (0=-5 to 10=+5)
	050006	Send/read AM TX Tone (Treble) level (0=-5 to 10=+5)
	050007	Send/read AM RX Tone (Bass) level (0=-5 to 10=+5)
	050008	Send/read AM RX Tone (Treble) level (0=-5 to 10=+5)
050009	Send/read FM TX Tone (Bass) level (0=-5 to 10=+5)	
050010	Send/read FM TX Tone (Treble) level (0=-5 to 10=+5)	

Command	Sub command	Description
1A	050011	Send/read FM RX Tone (Bass) level (0=-5 to 10=+5)
	050012	Send/read FM RX Tone (Treble) level (0=-5 to 10=+5)
	050013	Send/read SSB TX bandwidth for wide (see p. 14-10 for details)
	050014	Send/read SSB TX bandwidth for mid. (see p. 14-10 for details)
	050015	Send/read SSB TX bandwidth for narrow (see p. 14-10 for details)
	050016	Send/read speech level (0=0% to 255=100%)
	050017	Send/read CW side tone gain (0=min. to 255=max.)
	050018	Send/read CW side tone gain limit (0=OFF, 1=ON)
	050019	Send/read beep gain (0=min. to 255=max.)
	050020	Send/read beep gain limit (0=OFF, 1=ON)
	050021	Send/read headphones output ratio (0=0.60 to 255=1.40)
	050022	Send/read headphone output selection (0=separated, 1=mixed)
	050023	Send/read AF/SQL signal output to ACC-A (0=Main; 1=Sub)
	050024	Send/read AF/SQL signal output to ACC-B (0=Main; 1=Sub)
	050025	Send/read AF output level to ACC-A (0=0% to 255=100%)
	050026	Send/read AF output level to ACC-B (0=0% to 255=100%)
	050027	Send/read S/P DIF output level (0=0% to 255=100%)
	050028	Send/read MOD output level to ACC-A (0=0% to 255=100%)
	050029	Send/read MOD output level to ACC-B (0=0% to 255=100%)
	050030	Send/read S/P DIF MOD output level (0=0% to 255=100%)
	050031	Send/read MOD input connector during DATA OFF (0=MIC; 1=ACC-A; 2=ACC-B; 3=MIC/ACC-A; 4=MIC/ACC-B; 5=ACC-A/ACC-B; 6=MIC/ACC-A/ACC-B; 7=S/P DIF)
	050032	Send/read MOD input connector during DATA1 (0=MIC; 1=ACC-A; 2=ACC-B; 3=MIC/ACC-A; 4=MIC/ACC-B; 5=ACC-A/ACC-B; 6=MIC/ACC-A/ACC-B; 7=S/P DIF)
	050033	Send/read MOD input connector during DATA2 (0=MIC; 1=ACC-A; 2=ACC-B; 3=MIC/ACC-A; 4=MIC/ACC-B; 5=ACC-A/ACC-B; 6=MIC/ACC-A/ACC-B; 7=S/P DIF)
050034	Send/read MOD input connector during DATA3 (0=MIC; 1=ACC-A; 2=ACC-B; 3=MIC/ACC-A; 4=MIC/ACC-B; 5=ACC-A/ACC-B; 6=MIC/ACC-A/ACC-B; 7=S/P DIF)	

7800

◆ Command table (continued)

Command	Sub command	Description	Command	Sub command	Description
1A	050035	Send/read the band selection for operating frequency band signal output to ACC-A. (0=MAIN, 1=SUB, 2=TX)	1A	050057	Send/read opening message indication (0=OFF, 1=ON)
	050036	Send/read the band selection for operating frequency band signal output to ACC-A. (0=MAIN, 1=SUB, 2=TX)		050058	Send/read opening message contents (see p. 14-9 for details)
	050037	Send/read relay type selection (0=Lead, 1=MOS-FET)		050059	Send/read date (20000101=1st Jan. 2001 to 20991231=31st Dec. 2099)
	050038	Send/read main band's external meter output selection (0=Auto, 1=S (main), 2=Po, 3=SWR, 4=ALC, 5=COMP, 6=Vd, 7=Id)		050060	Send/read time (0000=00:00 to 2359=23:59)
	050039	Send/read sub band's external meter output selection (0=Auto, 1=S (sub), 2=Po, 3=SWR, 4=ALC, 5=COMP, 6=Vd, 7=Id)		050061	Send/read clock 2 function (0=OFF, 1=ON)
	050040	Send/read main band's external meter output level (0=0% to 255=100%)		050062	Send/read offset time for clock 2 (240001=-24:00 to 240000=+24:00)
	050041	Send/read sub band's external meter output level (0=0% to 255=100%)		050063	Send/read clock 2 name (up to 3-character; see p. 14-9)
	050042	Send/read reference signal in/out setting (0=OFF, 1=IN, 2=OUT)		050064	Send/read calibration marker (0=OFF, 1=ON)
	050043	Send/read reference signal frequency setting (0=0% to 255=100%)		050065	Send/read confirmation beep (0=OFF, 1=ON)
	050044	Send/read LCD unit backlight brightness (0=0% to 255=100%)		050066	Send/read band edge beep (0=OFF, 1=ON)
	050045	Send/read switch indicator brightness (0=0% to 255=100%)		050067	Send/read main band's beep audio frequency (50=500 Hz to 200=2000 Hz)
	050046	Send/read screen image type (0=A, 1=B, 2=C)		050068	Send/read sub band's beep audio frequency (50=500 Hz to 200=2000 Hz)
	050047	Send/read frequency readout font (0=Italic (1), 1=Italic (2), 2=Italic (3), 3=Italic (4), 4=Round (1), 5=Round (2), 6=Round (3), 7=Shadow (1), 8=Shadow (2), 9=Shadow (3), 10=Qubic (1), 11=Qubic (2), 12=Qubic (3), 13=Qubic (4), 14=IC-780 (1), 15=IC-780 (2), 16=IC-780 (3), 17=IC-780 (4))		050069	Send/read quick dualwatch function (0=OFF, 1=ON)
	050048	Send/read font for other than frequency readout (0=Normal, 1=Slim)		050070	Send/read quick split set (0=OFF, 1=ON)
	050049	Send/read meter type (0=Standard, 1=Edgewise, 2=Bar)		050071	Send/read FM split offset -9.999 to +9.999 MHz for HF (see p. 14-10 for details)
	050050	Send/read meter type during wide screen or mini scope indication (0=Edgewise, 1=Bar)		050072	Send/read FM split offset -9.999 to +9.999 MHz for 50 MHz (see p. 14-10 for details)
	050051	Send/read peak hold set (0=OFF, 1=ON)		050073	Send/read split lock set (0=OFF, 1=ON)
	050052	Send/read memory name indication setting (0=OFF, 1=ON)		050074	Send/read tuner auto start set (0=OFF, 1=ON)
	050053	Send/read audio peak filter width pop-up indication setting (0=OFF, 1=ON)		050075	Send/read PTT tune set (0=OFF, 1=ON)
	050054	Send/read manual notch width pop-up indication setting (0=OFF, 1=ON)		050076	Send/read transverter set (0=OFF, 1=ON)
	050055	Send/read output signal setting for external display (0=OFF, 1=ON)		050077	Send/read transverter offset (see p. 14-10 for details)
	050056	Send/read synchronous pulse level setting (0=L, 1=H)		050078	Send/read RTTY mark frequency (0=1275 Hz, 1=1615 Hz, 2=2125 Hz)
				050079	Send/read RTTY shift width (0=170 Hz, 1=200 Hz, 2=425 Hz)
				050080	Send/read RTTY keying polarity (0=Normal, 1=Reverse)
				050081	Send/read PSK tone frequency (0=1000 Hz, 1=1500 Hz, 2=2000 Hz)
				050082	Send/read speech language (0=English, 1=Japanese)
				050083	Send/read speech speed (0=Slow, 1=Fast)
		050084	Send/read S-level speech (0=OFF, 1=ON)		
		050085	Send/read speech with a mode switch operation (0=OFF, 1=ON)		
		050086	Send/read memo pad numbers (0=5 ch, 1=10 ch)		

◆ Command table (continued)

Command	Sub command	Description
1A	050087	Send/read main dial function (0=MAIN, 1=MAIN+SUB)
	050088	Send/read main dial auto TS (0=OFF, 1=Low, 2=High)
	050089	Send/read sub dial auto TS (0=OFF, 1=Low, 2=High)
	050090	Send/read mic. up/down speed (0=Low, 1=High)
	050091	Send/read quick RIT/ΔTX clear function (0=OFF, 1=ON)
	050092	Send/read SSB notch operation (0=Auto, 1=Manual, 2=Auto/Manual)
	050093	Send/read AM notch operation (0=Auto, 1=Manual, 2=Auto/Manual)
	050094	Send/read DIGI-SEL control function (0=DIGI-SEL, 1=APF)
	050095	Send/read band indication for filter set screen (0=Fix, 1=Auto)
	050096	Send/read SSB/CW synchronous tuning function (0=OFF, 1=ON)
	050097	Send/read CW normal side set (0=LSB, 1=USB)
	050098	Send/read PSK normal side set (0=LSB, 1=USB)
	050099	Send/read band setting for audio output from mic. connector (0=MAIN+SUB, 1=SUB)
	050100	Send/read external keypad set for voice memory (0=OFF, 1=ON)
	050101	Send/read external keypad set for keyer memory (0=OFF, 1=ON)
	050102	Send/read CI-V transceiver set (0=OFF, 1=ON)
	050103	Send/read RS-232C function (0=CI-V, 1=Decode)
	050104	Send/read RS-232C decode speed (0=300, 1=1200, 2=4800, 3=9600, 4=19200)
	050105	Send/read keyboard type (0=English, 1=Japanese)
	050106	Send/read keyboard repeat delay (10=100 msec. to 100=1000 msec.)
	050107	Send/read keyboard repeat speed (0=2.0 cps to 31=30.0 cps)
	050108	Send/read IP address set (0000000000000000=0.0.0.0 to 0255025502550255=255.255.255.255)
	050109	Send/read subnet mask (0=0.0.0.0 to 30=255.255.255.252)
	050110	Send/read scope indication during TX (0=OFF, 1=ON)
	050111	Send/read scope max. hold (0=OFF, 1=ON)
	050112	Send/read scope center frequency set (0=Filter center, 1=Carrier point center, 2=Carrier point center (Abs. Freq.))
	050113	Send/read waveform color for receiving signal (see p. 14-10 for details)
	050114	Send/read waveform color for max. hold (see p. 14-10 for details)

Command	Sub command	Description
1A	050115	Send/read scope sweep speed for ±2.5 kHz span (0=Slow, 1=Mid., 2=Fast)
	050116	Send/read scope sweep speed for ±5 kHz span (0=Slow, 1=Mid., 2=Fast)
	050117	Send/read scope sweep speed for ±10 kHz span (0=Slow, 1=Mid., 2=Fast)
	050118	Send/read scope sweep speed for ±25 kHz span (0=Slow, 1=Mid., 2=Fast)
	050119	Send/read scope sweep speed for ±50 kHz span (0=Slow, 1=Mid., 2=Fast)
	050120	Send/read scope sweep speed for ±100 kHz span (0=Slow, 1=Mid., 2=Fast)
	050121	Send/read scope sweep speed for ±250 kHz span (0=Slow, 1=Mid., 2=Fast)
	050122	Send/read scope edge frequencies for 0.03 to 1.60 MHz band (see p. 14-10 for details)
	050123	Send/read scope edge frequencies for 1.60 to 2.00 MHz band (see p. 14-10 for details)
	050124	Send/read scope edge frequencies for 2.00 to 6.00 MHz band (see p. 14-10 for details)
	050125	Send/read scope edge frequencies for 6.00 to 8.00 MHz band (see p. 14-10 for details)
	050126	Send/read scope edge frequencies for 8.00 to 11.00 MHz band (see p. 14-10 for details)
	050127	Send/read scope edge frequencies for 11.00 to 15.00 MHz band (see p. 14-10 for details)
	050128	Send/read scope edge frequencies for 15.00 to 20.00 MHz band (see p. 14-10 for details)
	050129	Send/read scope edge frequencies for 20.00 to 22.00 MHz band (see p. 14-10 for details)
	050130	Send/read scope edge frequencies for 22.00 to 26.00 MHz band (see p. 14-10 for details)
	050131	Send/read scope edge frequencies for 26.00 to 30.00 MHz band (see p. 14-10 for details)
	050132	Send/read scope edge frequencies for 30.00 to 45.00 MHz band (see p. 14-10 for details)
	050133	Send/read scope edge frequencies for 45.00 to 60.00 MHz band (see p. 14-10 for details)
	050134	Send/read auto voice monitor set (0=OFF, 1=ON)
	050135	Send/read voice memory short play time (3=3 sec. to 10=10 sec.)
	050136	Send/read voice memory normal record time (5= 5 sec. to 15=15 sec.)

7800

◇ Command table (continued)

Command	Sub command	Description
1A	050137	Send/read contest number style (0=Normal, 1=190→ANO, 2=190→ANT, 3=90→NO, 4=90→NT)
	050138	Send/read count up trigger channel (1=M1, 2=M2, 3=M3, 4=M4)
	050139	Send/read present number (1-9999)
	050140	Send/read CW keyer repeat time (1=1 sec. to 60=60 sec.)
	050141	Send/read CW keyer dot/dash ratio (28=1:1:2.8 to 45=1:1:4.5)
	050142	Send/read rise time (0=2 msec., 1=4 msec., 2=6 msec., 3=8 msec.)
	050143	Send/read paddle polarity (0=Normal, 1=Reverse)
	050144	Send/read keyer type (0=Straight, 1=Bug-key, 2=ELEC-Key)
	050145	Send/read mic. up/down keyer set (0=OFF, 1=ON)
	050146	Send/read RTTY decode USOS (0=OFF, 1=ON)
	050147	Send/read RTTY decode new line code (0=CR,LF,CR+LF, 1=CR+LF)
	050148	Send/read RTTY middle (0=OFF, 1=Blank, 2=Letter)
	050149	Send/read RTTY TX USOS (0=OFF, 1=ON)
	050150	Send/read RTTY auto CR+LF by TX (0=OFF, 1=ON)
	050151	Send/read RTTY time stamp set (0=OFF, 1=ON)
	050152	Send/read clock selection for time stamp (0=Local time, 1=Clock 2)
	050153	Send/read frequency stamp (0=OFF, 1=ON)
	050154	Send/read received text font color (see p. 14-10 for details)
	050155	Send/read transmitted text font color (see p. 14-10 for details)
	050156	Send/read time stamp text font color (see p. 14-10 for details)
	050157	Send/read text font color in TX buffer (see p. 14-10 for details)
	050158	Send/read PSK time stamp set (0=OFF, 1=ON)
	050159	Send/read clock selection for time stamp (0=Local time, 1=Clock 2)
	050160	Send/read frequency stamp (0=OFF, 1=ON)
	050161	Send/read received text font color (see p. 14-10 for details)
	050162	Send/read transmitted text font color (see p. 14-10 for details)
	050163	Send/read time stamp text font color (see p. 14-10 for details)
050164	Send/read text font color in TX buffer (see p. 14-10 for details)	
050165	Send/read scan speed (0=Low, 1=High)	
050166	Send/read scan resume (0=OFF, 1=ON)	
050167	Send/read antenna selection for 0.03 to 1.60 MHz band (see p. 14-10 for details)	

Command	Sub command	Description
1A	050168	Send/read antenna selection for 1.60 to 2.00 MHz band (see p. 14-10 for details)
	050169	Send/read antenna selection for 2.00 to 6.00 MHz band (see p. 14-10 for details)
	050170	Send/read antenna selection for 6.00 to 8.00 MHz band (see p. 14-10 for details)
	050171	Send/read antenna selection for 8.00 to 11.00 MHz band (see p. 14-10 for details)
	050172	Send/read antenna selection for 11.00 to 15.00 MHz band (see p. 14-10 for details)
	050173	Send/read antenna selection for 15.00 to 20.00 MHz band (see p. 14-10 for details)
	050174	Send/read antenna selection for 20.00 to 22.00 MHz band (see p. 14-10 for details)
	050175	Send/read antenna selection for 22.00 to 26.00 MHz band (see p. 14-10 for details)
	050176	Send/read antenna selection for 26.00 to 30.00 MHz band (see p. 14-10 for details)
	050177	Send/read antenna selection for 30.00 to 45.00 MHz band (see p. 14-10 for details)
	050178	Send/read antenna selection for 45.00 to 60.00 MHz band (see p. 14-10 for details)
	050179	Send/read antenna temporary memory set (0=OFF, 1=ON)
	050180	Send/read antenna selection (0=OFF, 1=Manual, 2=Auto)
	050181	Send/read usage for ANT2 (0=OFF, 1=TX/RX)
	050182	Send/read usage for ANT3 (0=OFF, 1=TX/RX)
	050183	Send/read usage for ANT4 (0=OFF, 1=TX/RX, 2= RX)
	050184	Send/read VOX delay (0=0.0 sec. to 20=2.0 sec.)
050185	Send/read VOX voice delay (0=OFF, 1=Short, 2=Long)	
050186	Send/read NB depth (0=1 to 9=10)	
050187	Send/read NB width (0=0 to 255=255)	
	06	Send/read DATA mode with filter set (see p. 14-10 for detail)
	07	Send/read SSB transmit bandwidth (0=WIDE, 1=MID, 2=NAR)
	08	Send/read DSP filter shape (0= sharp, 1= soft)
	09	Send/read roofing filter set (0=6 kHz, 1=15 kHz)
	0A	Send/read manual notch width (0=Wide, 1=Mid., 2=Nar.)
	10	Send/read lock function set (0=OFF, 1=ON)

◇ Command table (continued)

Command	Sub command	Description
1B	00	Set/read repeater tone frequency (see p. 14-10 for details)
	01	Set/read TSQL tone frequency (see p. 14-10 for details)
1C	00	Set/read the transceiver's condition (0=Rx; 1=Tx)
	01	Set/read antenna tuner condition (0=OFF, 1=ON, 2=Start tuning or while tuning)

7800

◆ To send/read memory contents

When sending or reading memory contents, additional code as follows must be added to appoint the memory channel.

➤ Additional code: 0000-0101 (0100=P1, 0101=P2)

◆ Band stacking register

To send or read the desired band stacking register's contents, combined code of the frequency band and register codes as follows are used.

For example, when sending/reading the oldest contents in the 21 MHz band, the code "0703" is used.

• Frequency band code

Code	Frequency band	Frequency range (unit: MHz)
01	1.8	1.800000- 1.999999
02	3.5	3.400000- 4.099999
03	7	6.900000- 7.499999
04	10	9.900000-10.499999
05	14	13.900000-14.499999
06	18	17.900000-18.499999
07	21	20.900000-21.499999
08	24	24.400000-25.099999
09	28	28.000000-29.999999
10	50	50.000000-54.000000
12	GENE	Other than above

• Register code

Code	Registered number
01	1 (latest)
02	2
03	3 (oldest)

◆ Codes for memory keyer contents

To send or read the desired memory keyer contents, the channel and character codes as follows are used.

• Channel code

Code	Channel number
01	M1
02	M2
03	M3
04	M4

• Character's code

Character	ASCII code	Description
0-9	30-39	Numerals
A-Z	41-5A	Alphabetical characters
space	20	Word space
/	2F	Symbol
?	3F	Symbol
,	2C	Symbol
.	2E	Symbol
^	5E	e.g., to send BT, enter ^4254
*	2A	Inserts contest number (can be used for 1 channel only)

◆ Codes for memory name, opening message and clock 2 name contents

To send or read the desired memory name settings, the character codes, instructed codes for memory keyer contents as above, and follows are additionally used.

• Character's code— Alphabetical characters

Character	ASCII code	Character	ASCII code
a-z	61-7A	—	—

• Character's code— Symbols

Character	ASCII code	Character	ASCII code
!	21	#	23
\$	24	%	25
&	26	¥	5C
?	3F	"	22
'	27	`	60
+	2B	-	2D
:	3A	;	3B
=	3D	<	3C
>	3E	(28
)	29	[5B
]	5D	{	7B
}	7D		7C
_	5F	-	7E
@			

◆ Offset frequency setting

The following data sequence is used when sending or reading the offset frequency setting.

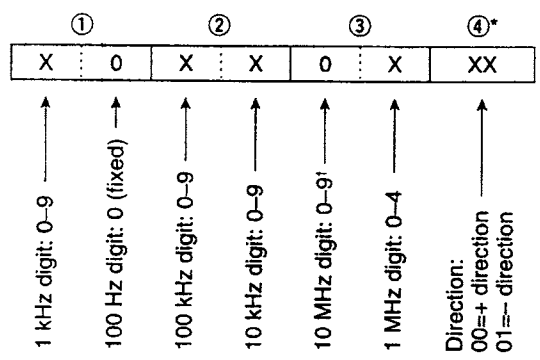

*No need to enter for transverter offset frequency setting.
 †Transverter offset only; Fix to '0' for split offset setting.

◆ Repeater tone/tone squelch frequency setting

The following data sequence is used when sending or reading the tone frequency setting.

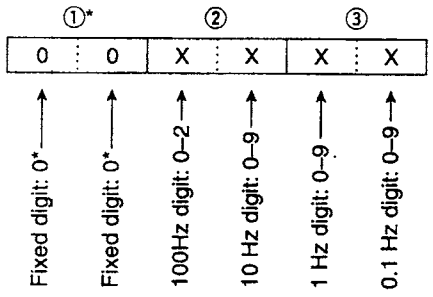

*Not necessary when setting a frequency.

◆ SSB transmission passband width setting

The following data sequence is used when sending or reading the SSB transmission passband width setting.

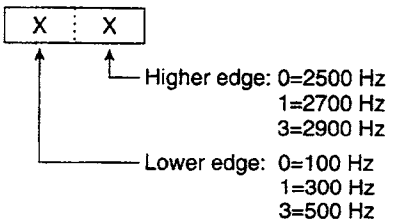

◆ Color setting

The following data sequence is used when sending or reading the color setting.

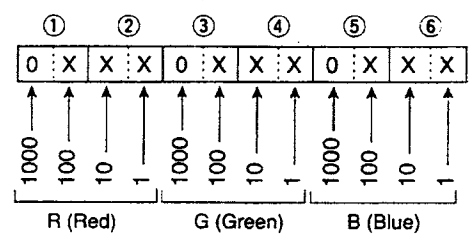

Using 0000-0255 for each color element.

◆ Bandscope edge frequency setting

The following data sequence is used when sending or reading the bandscope edge frequency setting.

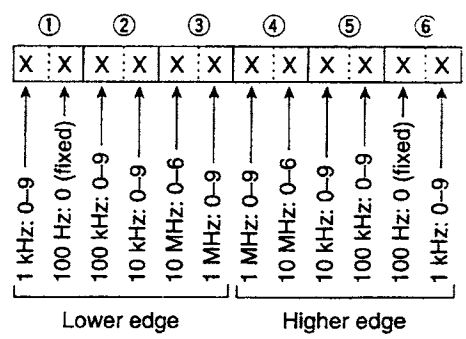

◆ Data mode with filter width setting

The following data sequence is used when sending or reading the data mode with filter width setting.

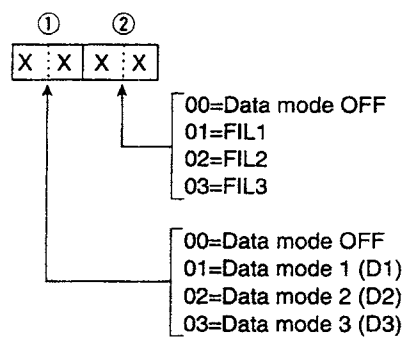

◆ Antenna memory setting

The following codes are used when sending or reading the antenna memory setting.

- 0=ANT1, 1=ANT2, 2=ANT3, 3=ANT4,
- 4*=TX: ANT1, RX: ANT4, 5*=TX: ANT2, RX: ANT4,
- 6*=TX: ANT3, RX: ANT4

*RX should be selected for ANT4